

Human motion range data optimizes anthropomorphic robotic hand-arm system design

Heiko Panzer and Oliver Eiberger and Markus Grebenstein and Peter Schaefer and Patrick van der Smagt

Abstract At the Institute of Robotics and Mechatronics of the German Aerospace Center (DLR Oberpfaffenhofen), a robotic hand-arm system is being developed, which will consist of a 19 active degree-of-freedom (DoF) hand and a 7 active DoF flexible arm based on antagonistic drive principles. It is targeted to mimic human hand and arm motion as closely as possible, taking kinematic as well as dynamic ranges into account. In the development of such a highly anthropomorphic hand-arm system, the motion of the human arm plays a key role. While the study of kinematic and dynamic ranges in humans has been done in various sources in literature, none of these are however directly applicable to the developed robotic system. We approached this problem by using RAMSIS data recorded at the Department of Ergonomics at the technical university of Munich. By creating a three-dimensional multi-mode visualisation tool, these data were made available for laying out the dimensions and localisations of the 52 actuators that control the hand-arm system.

1 Introduction

At the Institute of Robotics and Mechatronics of the German Aerospace Center (DLR Oberpfaffenhofen), an effort is underway to construct a robotic system mimicking the kinematics and dynamics of the human arm using modern mechatronic approaches, a model of which is shown in Figure 1. This system is based on a co-contractive (antagonistic) drive system with joint structures as close to the biological counterpart as possible [3]. In order to construct this system, detailed knowledge of the human hand and arm is required. Much of these data can be obtained by studying

Heiko Panzer, Oliver Eiberger, Markus Grebenstein, and Patrick van der Smagt
Institute of Robotics and Mechatronics, German Aerospace Center (DLR Oberpfaffenhofen), P.O. Box 1116, 82230 Wessling, e-mail: smagt@dlr.de

Peter Schaefer
Institute of Ergonomics, TU Munich, Boltzmannstrasse 15 85747 Garching, Germany

corpses; the larger part of these information is available in medical literature. Naturally, dynamics data of the arm can only be obtained *in vivo*. Creating a human-like

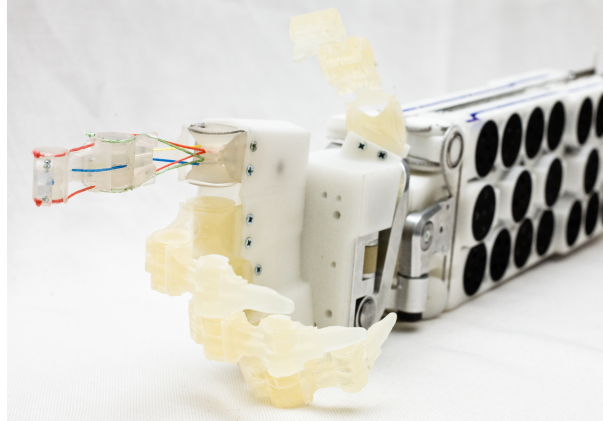

Fig. 1 Model of the DLR integrated hand-arm system.

hand-arm system means imparting it the same abilities and skills that a human arm can perform. Obviously, an important point is the force or torque, respectively, that the arm is able to exceed; hence the performance of the arm must be examined. Due to the kinematics of the robot arm and the anatomy of the human arm, however, this maximum load varies with the joint position or the alignment of the arm, respectively. In consequence, instead of measuring a single force or torque value, one has to study the capacity of the human arm in much detail in order to be able to state information on how much the arm can render in a given position. This was the very goal of the RAMSIS human model [1] (although RAMSIS should predict maximum loads upon the whole body, not only the arm), that has now been used for the purpose of a robot arms construction.

The human arm is a seven degree of freedom (DoF) kinematic chain. It consists of a three-DoF ball joint at the shoulder which, in combination with a two-DOF shoulder girdle, allows an impressive motion range. The second and third part is a single-DoF elbow and a rather complex three-DoF wrist for forearm rotation as well as non-cardanic pitch and yaw motion for the hand.

2 Construction of a biomimetic hand-arm system

When constructing a robotic system with mechanical variable impedance, all joints are governed by the same principle: a joint must have an inherent mechanical flexibility with variable, nonlinear spring, and be biactuated to realise that. The development of antagonistic robot joints is a multi-disciplinary challenge rather than a me-

chanical problem. Therefore, a large antagonistic system requires a complete system design, including control strategies for the most important control modes. Due to the elastic elements, every motor action in an antagonistic system will induce vibration. Flexibility at the joint level requires the inclusion of a nonlinear spring between the actuator and the joint. Two different principles can be distinguished in the literature: those based on linear springs, and those based on nonlinear (typically rubber-based) elements.

Due to their compact size and high force-to-weight ratio, dc motors are a more optimal candidate for actuation in anthropomorphic systems. Most approaches consist of two motors working against (to increase stiffness) or with (to change position) each other, and are connected over gear boxes via elastic elements. In most cases, these elastic elements consist of springs. Since springs are linear, however, these alone do not suffice: increasing the force of a linear spring does not increase its stiffness. Therefore, such solutions have to include a mechanism changing the linear properties of the spring into a nonlinear behaviour.

There have been different approaches towards obtaining nonlinear springs in the literature. Morita and Sugano [5] used a spring leaf with varying length in order to induce nonlinearities on the spring. The construction, however, was difficult and error-prone, and lead to a complex nonlinear transfer function. Migliore et al. [4] used a special spring device inducing a force-length relationship which can be determined by the curvature of a bar extending two springs. The construction is relatively large and may suffer from nonlinear friction and wear-and-tear. Tonietti et al. [6] introduced a variable stiffness actuator, a rather complex and large structure actuating three springs with tendons over rollers. English and Russell [2] construct an antagonistic elbow joint using similar approaches as presented in this paper. However, in our approach the elbow actuators cannot be placed in the lower arm, since that space is needed for the hand actuators. Also, they assume that arm stiffness is independent of joint position, but that would lead to linear springs and remove the requirement of robustness against collisions, since the stiffness near the joint limit would not increase, as it does in our case.

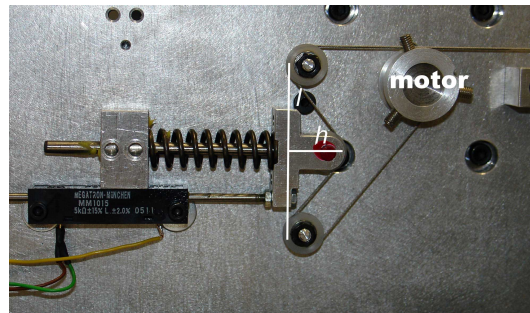

Fig. 2 Setup for a biarticulate joint with a nonlinear spring. Height h of the triangle relative to $l/2$ determines the stiffness constant.

The antagonistic concept, that we use to control the fingers of the hand, follows the approach by Tonietti et al., but in a significantly simplified form. In our setup, each motor is equipped with a nonlinear spring element (see Figure 2). Each element consists of a linear spring which pushes the tendon, forming it into a triangle. The height h of this triangle relative to half base l determines the stiffness constant of the construction. Two motors, each of which is equipped with a nonlinear spring element, then can be used to increase the total stiffness (up to infinite stiffness) by pulling in counter directions, since their tendons are stiffly connected to each other via the joint that they are controlling.

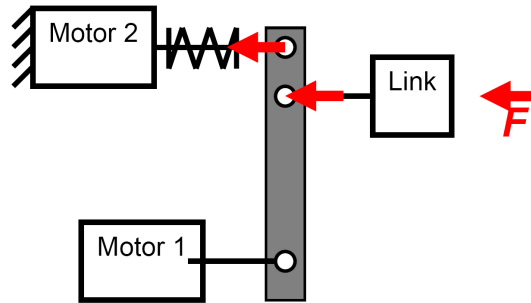

Fig. 3 Setup for a variable impedance joint with a preloadable spring.

The arm dynamics are more prominent than hand dynamics, due to the higher masses that have to be moved. To get an optimal performance at minimal weight, it was chosen to use a large motor (Motor 1 in Figure 3) for joint positioning, and a small motor (Motor 2) for adapting the spring characteristics of the joint. Thus the antagonistic approach was only used to control the fingers of the hand; a variable impedance approach for the arm. In order to obtain nonlinearity in the spring properties, the joint is connected to the link via a cam disk, which preloads the spring when the joint is moved (see Figure 4). The form of the cam disk can be freely chosen, in order to get different nonlinearity properties of the spring; normally, however, it will be circular as depicted below.

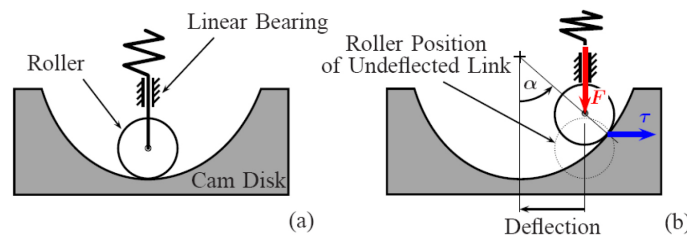

Fig. 4 Cam disk for nonlinearising the spring. The deflection, due to joint movement, preloads the spring during movement.

Considering the construction of the full arm, the actuators must be parameterised with respect to their moment and position, so as to have the forces resemble those of the human arm. This parameterisation can only be done, when the corresponding movements in the human arm are known. This requires knowledge of the maximum forces and moments that can be exerted by the human arm, dependent of the positions of the joints.

3 Local stress analysis and the torque bubble

The central idea of load evaluation by the RAMSIS human model is the principle of local stress analysis. This means, that unlike former evaluation techniques, loads upon a human body are not rated with respect to a complete posture or specific action, but their resulting moment of force upon each single joint is calculated in order to compare the actual stress to the maximum stress the joint can bear (Fig. 5). If every resulting charge is within its constraints, the global load can be sustained or mustered, respectively; otherwise, it is undue.

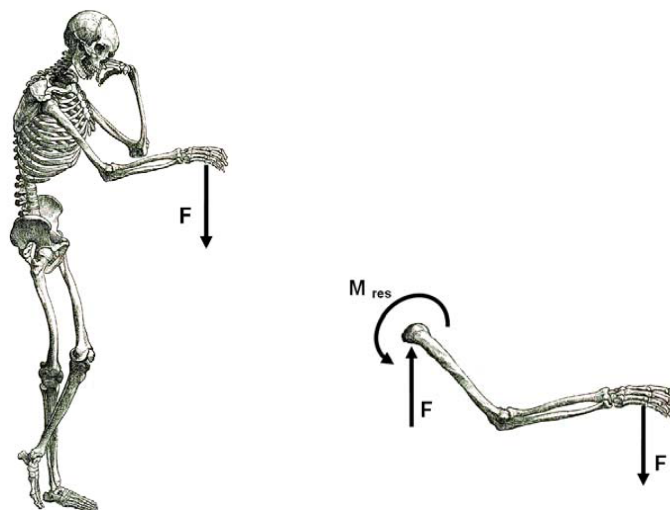

Fig. 5 Example demonstrating the principle of local stress analysis. Left: global load on hand; right: resultant stress on the shoulder joint.

Due to our anatomy, the resultant turning moments do in general occur as a combination of bending moments and torsion moments, thus pointing into an arbitrary direction. At the same time, the maximum torque value a joint can bear certainly depends both on the torques direction and the joint position. Plotting the tie points of the maximum torque vectors into every direction around the joint yields the set of all turning moments that can just about be sustained. For the reasons seen above, these

vectors are accommodated by some kind of distorted bubble, an unconformable three-dimensional shape (Fig. 6).

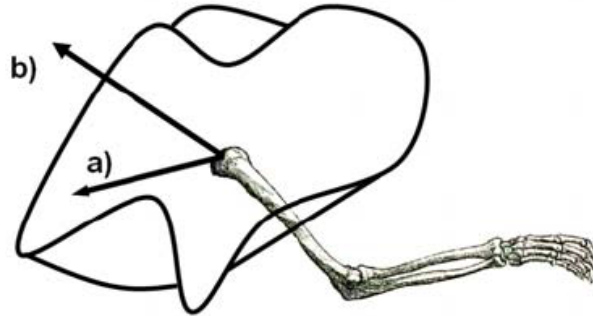

Fig. 6 Sustainability consideration. a) tolerable load; b) undue load.

Consequently, to decide whether an external load is sustainable, one has to check for every joint if the resultant torque vector lies within the boundaries of the torque bubble measured for the respective joint position (Fig. 6a) or not (Fig. 6b).

This implies the need of exact knowledge of the bubble shape for every joint position, which naturally is impossible to acquire. For that reason, one manages with the following approximation: For a given ball joint position, one approaches the bubble by segmentally defined ellipsoids each of which is determined by diameter and height the individual diameters corresponding to bending moments, the height to torsional moments (Fig. 7). For joints that allow less degrees of freedom (DoF), e.g. the knee (one DoF: deflection) or the elbow (two DoF: deflection and rotation), the three-dimensional bubble degenerates into other shapes, e.g. two-dimensional ellipse-like areas.

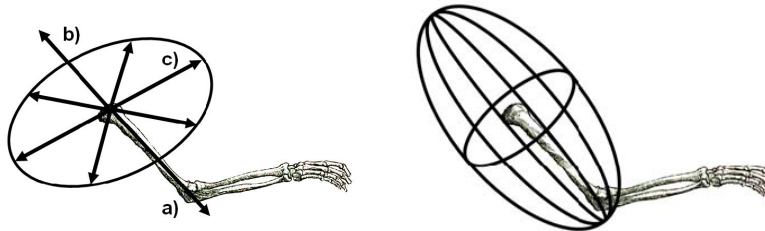

Fig. 7 Composition of the torque bubbles. a) and b) parallel and anti-parallel torsion; c) bending moment; d) exemplary simplified moment bubble.

4 Relevance to the hand-arm system

The goal in constructing future robot hands and arms is maximum flexibility and performance. Following nature's example, they shall be able to fulfil the same tasks as a human arm, develop the same skill and the same strength.

Just like human arms, however, they will always feature preferred directions in which their fortitude culminates and others, where they cannot perform their maximum forces or torques, respectively. And this is where the gathered data described above comes into play: It shall now be used to design a most human-like new robot arm whose preferred and non-preferred orientations are congruent with the respective orientations of a human arm. Interpreting however the data given in several voluminous tables, shapes up as a highly challenging task and gives rise to the need of more vivid illustration.

Therefore, a visualisation tool has been programmed in order to ease the imagination of the torque bubbles explained before.

5 Visualization tool for shoulder torque bubble

The implementation of the visualization tool was effected under Matlab and includes two screens (Fig. 8). On the down right side one can see the position of the arm which permits quick orientation. On the left hand side, the measuring points are charted and interpolated by an ellipse-like curve corresponding to the bending moments. Naturally, the view can be rotated freely in three dimensions; in Fig. 8 however, it is directed along the outstretched arm towards the shoulder joint (i.e., the origin).

Yet another type of presentation has been provided, that is to say a multiple view of several or all available torque ellipses (Fig. 9). For that purpose, the curves are not plotted around the centre of the shoulder joint but around the outstretched arm. Thus, one can more easily derive patterns or estimate the position of maximum and minimum fortitude.

6 Conclusion

Translating a human arm to a technical system demands to determine workspaces, torque capacities and a technical kinematics representation.

The passive elasticity of the DLR hand-arm system is a subject of research. This is especially true for the chosen shoulder kinematics, so that it allow for stiffness variation between typical motion directions as well as across such directions. As the elasticity is intrinsic to the joints we built, the shoulder was decided to be constructed as a kinematic chain, rather than a single 3-DoF joint. Combined with other investigations, the torque bubble data is used to find strong and weak postures and

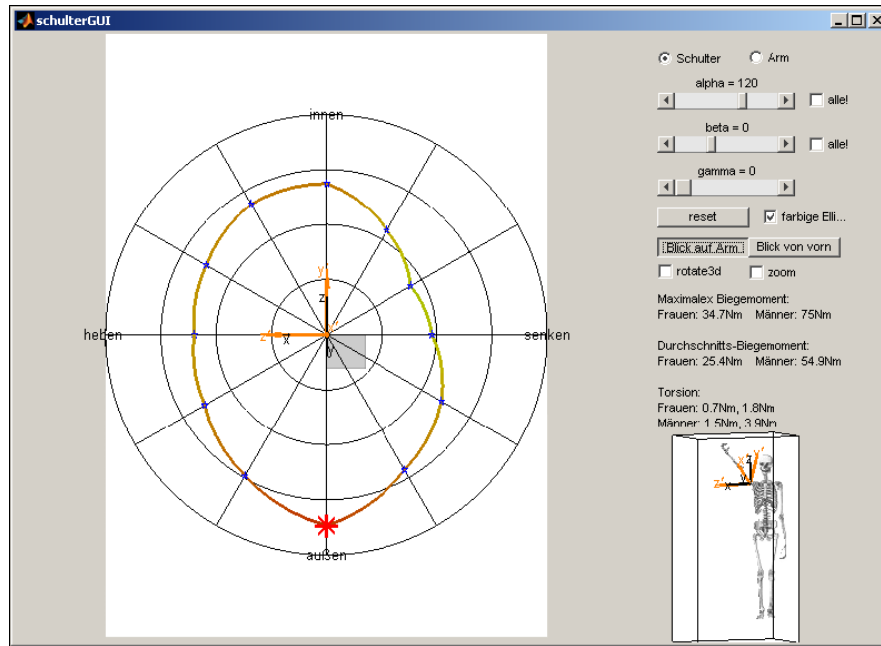

Fig. 8 Screenshot of the visualization tool in shoulder mode.

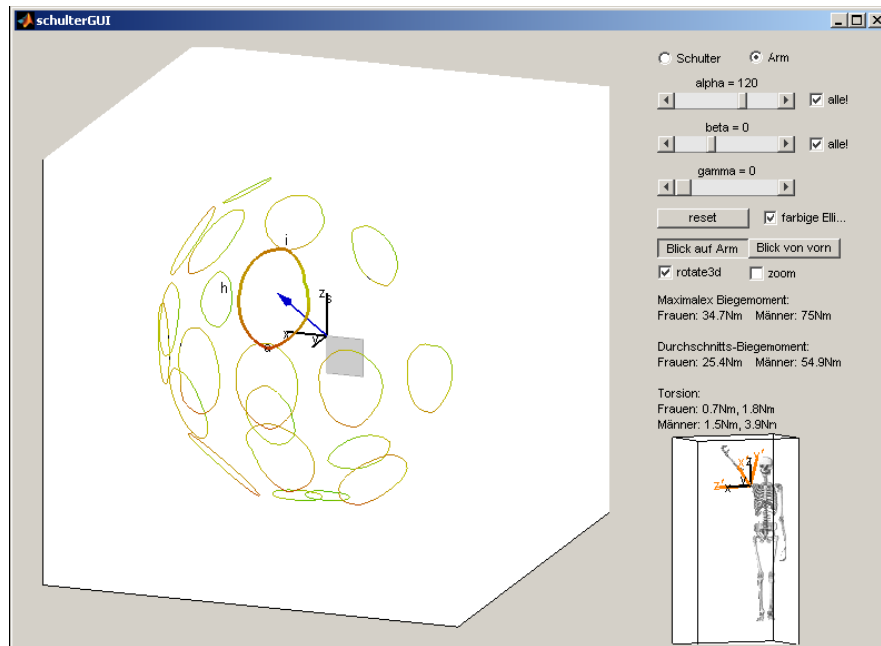

Fig. 9 Screenshot of the visualization tool in multi-mode.

force directions as well as typical motion directions, in order to derive a suitable kinematics configuration for the shoulder joint axes. Maxima in the torque bubbles show required torque capacities for the joint, while minima denote possible singular positions, and the distribution of the maxima indicates main axis directions as well as axis follow ups for the robot shoulder kinematics. Therefore, the approach described in this paper will allow us to construct an optimal shoulder.

Acknowledgment. This work has been partly funded by SENSOPAC (FP6-IST-028056).

References

1. H. Bubb, F. Engstler, F. Fritzsche, Ch. Mergl, O. Sabbah, P. Schaefer, and I. Zacher. The development of RAMSIS in past and future as an example for the cooperation between industry and university. *Int. J. of Human Factors Modelling and Simulation*, 1(1):140–157, 1996.
2. C. E. English and D. Russell. Implementation of variable joint stiffness through antagonistic actuation using rolamite springs. *Mechanism and Machine Theory*, 34(1):27–40, 1999.
3. M. Grebenstein and P. van der Smagt. Antagonism for a highly anthropomorphic handarm system. *Advanced Robotics*, 22:39–55, 2008.
4. S. A. Migliore, E. A. Brown, and S. P. Deweerth. Biologically inspired joint stiffness control. In *Proc. IEEE International Conference on Robotics and Automation*, pages 4519–4524, 2005.
5. T. Morita and S. Sugano. Design and development of a new robot joint using a mechanical impedance adjuster. In *Proc. IEEE Int. Conf. on Robotics and Automation*, pages 2469–2475, 1995.
6. G. Tonietti, R. Schiavi, and A. Bicchi. Design and control of a variable stiffness actuator for safe and fast physical human/robot interaction. In *Proc. IEEE Int. Conf. on Robotics and Automation*, pages 528–533, 2005.