

Provided for non-commercial research and education use.  
Not for reproduction, distribution or commercial use.

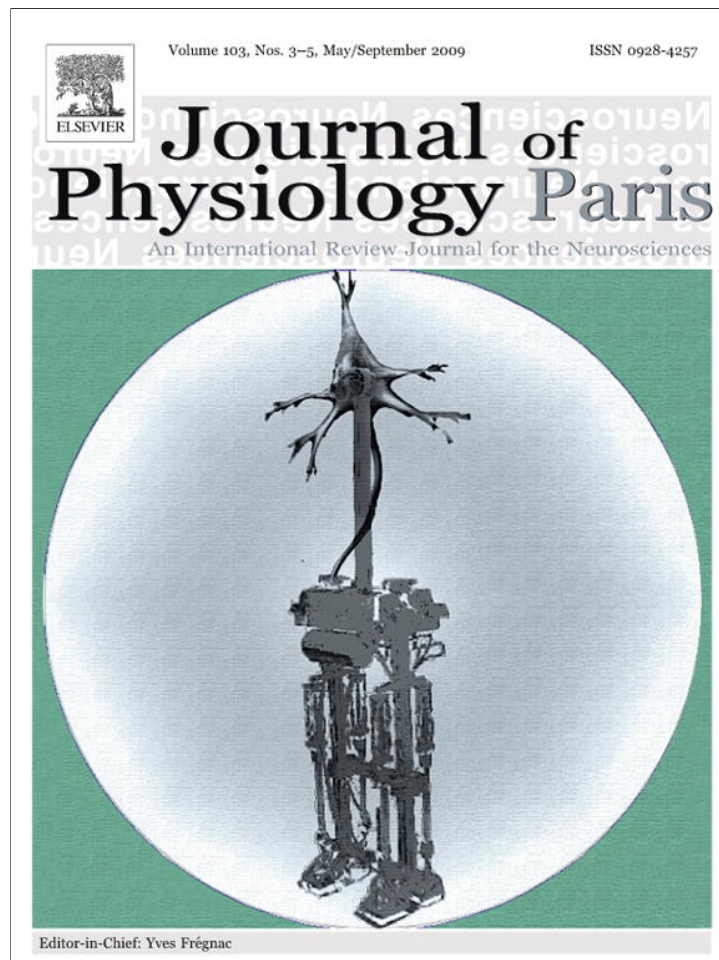

This article appeared in a journal published by Elsevier. The attached copy is furnished to the author for internal non-commercial research and education use, including for instruction at the authors institution and sharing with colleagues.

Other uses, including reproduction and distribution, or selling or licensing copies, or posting to personal, institutional or third party websites are prohibited.

In most cases authors are permitted to post their version of the article (e.g. in Word or Tex form) to their personal website or institutional repository. Authors requiring further information regarding Elsevier's archiving and manuscript policies are encouraged to visit:

<http://www.elsevier.com/copyright>



## Robotics of human movements

Patrick van der Smagt\*, Markus Grebenstein, Holger Urbanek, Nadine Fligge, Michael Strohmayer, Georg Stillfried, Jonathon Parrish, Agneta Gustus

Institute of Robotics and Mechatronics, German Aerospace Center, P.O. Box 1116, 82234 Wessling, Germany

### ARTICLE INFO

#### Keywords:

Variable impedance actuation  
Human-in-the-loop  
Biomimetic robotics  
Touch sensing  
Human-like arm

### ABSTRACT

The construction of robotic systems that can move the way humans do, with respect to agility, stability and precision, is a necessary prerequisite for the successful integration of robotic systems in human environments. We explain human-centered views on robotics, based on the three basic ingredients (1) actuation; (2) sensing; and (3) control, and formulate detailed examples thereof.

© 2009 Elsevier Ltd. All rights reserved.

### 1. Introduction

Robots have always been inspired by the human body. From the first robotic systems appearing in movie theatres to modern motion pictures, the robotic system has always played the role of “replacing” and “confronting” the human being, often with a remarkable resemblance. At a macroscopic level, the same holds true for industrial robotic systems. Robotic arms are a standard component in various manufacturing processes (the automobile industry is a prominent example), and their kinematics of which are often clearly inspired by the human arm.

Nevertheless, in most cases the resemblance ends there. Industrial robots, as well as most robotic systems found in research labs around the world, focus on high-precision positioning of the end-effector (see Fig. 1). However, their high rigidity and weight prohibits an integration of man and machine: the robots are kept in a cage to avoid life-threatening collisions. Biologically inspired applications, on the other hand, do not rely on such a high level of precision, but rather on a situation based fine-tuning of the end-effector position.

The need is growing for robotic systems which can cooperate with humans or even replace them in hazardous environments. To attain this ambitious goal, the following topics must be addressed:

- The development of light-weight robotic systems, having a (human-like) force-to-weight ratio of around 4:1, while reaching dynamic properties similar to those found in biology.
- The development of robotic systems which can freely interact with their environment, i.e., are safe for themselves as well as for their environment.

- Systems with ample energy efficiency.
- The sensing required for doing the required tasks.

All of these elements will further robotic systems towards obtaining a level of embodied intelligence that can be found in their biological ancestors: the intelligence to cope with physical environment interaction in a natural and energy efficient manner. They cannot be attained, however, without studying nature in detail, finding solutions for the problems at hand.

#### 1.1. Bionics

Several definitions of Bionics have been put forward, and several well-known examples (“lotus effect”, “shark skin”, Velcro) clearly demonstrate what it is all about: by looking how problems are solved in nature, technical solutions to existing problems can be found. In this approach, however, we have to distinguish *form* from *function*. In many cases, the bionics approach is to *copy* effects found in biology. An example is the lotus effect: by carefully studying the microscopic form of the leaves of the lotus flower, their water repellent function can be studied and copied in technical materials (see Fig. 2).

The technological complexity of the robotic systems that we develop does not allow us to closely copy nature. Our approach to bionics differs fundamentally: after studying a biological system, we carefully analyse and model its *function*. Using state-of-the-art technological solutions, we then use these models to copy the behaviour of the biological system, without necessarily taking the original *form* into account.

In each of the three major sections of this paper, we will demonstrate this approach:

- In the *Actuation* section, studies of muscle behaviour as well as the kinematic and dynamic properties of the human arm will make us propose a technical system which will *behave* as its bio-

\* Corresponding author. Tel.: +49 8153 281152.  
E-mail address: [smagt@dlr.de](mailto:smagt@dlr.de) (P. van der Smagt).

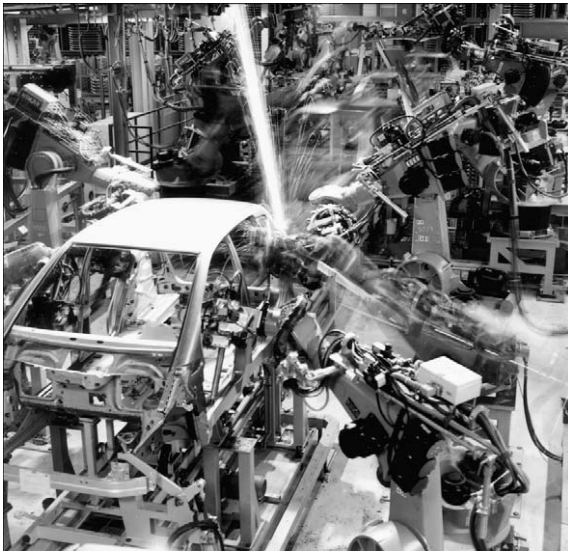

Fig. 1. Robotic systems in a modern automobile production line. © KUKA Roboter GmbH.



Fig. 2. Lotus effect. (From: Wikimedia, 2008, © Ralf Pfeifer.)

logical counterpart, but which is based on radically different technologies. Clearly, we cannot copy biology here: currently no actuation systems (“artificial muscles”) exist with ample efficiency (primarily force-to-weight and force-to-size ratio but also power consumption). There has been tremendous progress in the development of artificial muscle systems, e.g., based on Electro Active Polymers (EAPs), but their energy density is not even near their biological counterparts. Although the use of biological muscle is subject to research, application of such techniques is still far ahead. Instead, we use rotary actuators. Thus, we can attain ample energy density, while being able to approach all other muscle functions, such as those necessary to solve everyday human manipulation tasks. With our currently developed robotic hand, we copy the function of the biological hand in terms of kinematics, compliance and stiffness, but the technical implementation differs from biological joints.

- In the *Sensing* section, we will show how measurements and bio-mechanical properties of the human skin can be used in the development of novel tactile sensing systems. Here, again, copying the (sensor organs in) the human skin is not possible, since (a) we do not have the required technology for creating similar touch organs, and (b) those biological sensors are based on their incorporation with the biological peripheral nervous system. It is technologically highly inefficient to combine the two systems; therefore, rather than using a high-density network of “binary”

(spiking) sensors, it is replaced by a lower-density network of analogue sensors. A similar level of efficiency will be attained using the same, extracted, principle, yet the implementation is radically different.

- In the *Control* section, we will show how we study behavioural properties of the human skeletomuscular system (in particular, the arm) and how these results can be used in the high-level control of novel robotic systems; also, how neurological models can be employed in the control of robotic systems. First, knowledge of human motion behaviour, in this case focused on the motion of the human arm during typical, high dynamics, tasks will give us information on the dynamics required to cope with our environment. This involves the exerted *force* (how strong does my hand grasp a particular object) and *impedance* (what is the stiffness of my arm in a particular direction when I am performing a specific task, and why is it so) as well as the trajectory (for instance, why and in which cases is minimum jerk or minimum torque change used in determining the kinematic trajectory of biological systems). Second, we will make an excursion into the control of biological skeletomuscular structures by the cerebellum, and evaluate the usefulness of cerebellar systems for the control of robots. Here, again, we will discover the discrepancy between form and function: what is the precise task of the cerebellum, and in how far is its structure and functionality dependant on the controlled musculoskeletal system, and on the properties of the peripheral nervous system, forming the (intelligent) interface between the “controller” and the “actuator”.

The final questions that remain to be asked are: Why is the skeletomuscular system as it is? Why do humans use 29 muscle groups for the planar movement of the arm (elbow and shoulder joints), whereas a robotic system could do with two or four? Why does biology use biarticular muscles, actuating multiple joints at the same time? Are all of these properties remainders of days long gone; are they related to the properties of muscles; or do they have a function with respect to the control system?

### 1.2. We have the technology

It is only very recent that the technology has emerged to develop robotic systems which can exhibit dynamic and kinematic properties that approach some of the fundamental properties of skeletomuscular systems. Unfortunately, biological energy efficiency is far from being attainable. The scenario of running around for a day on two or three simple meals while solving complex cognitive tasks is unlikely to be matched by robotic systems in the near future. However, the energy density, i.e., force-to-weight ratio, that can be found in biology is no longer orders of magnitude away from what technological systems can attain. This has been successfully demonstrated by the latest developments in hydraulic actuation as well as dc motor technology.

Apart from the perfection of existing technologies, new lines of technology, which are based on nanotechnology, but also on other chemical processes, may demonstrate the next line of actuation and sensing that lies ahead of us. At this moment, however, those systems are far from perfect and currently not even remotely match our needs.

### 1.3. Towards

How does this bag of advanced components give us a complete system? The Japanese 90s MITI initiative on the development of humanoid robots has changed the world's view on robots. While

robotic systems were mostly targeted on industrial applications before those days, this initiative made us believe that the technology, necessary for developing human-like robot companions, was at the doorstep. Despite the huge amount of useful and impressive research that was conducted in those days, in hindsight it was clear that the necessary technology was not yet available to solve the major problems at hand. The line of research developed various platforms which looked rather human, but exhibited movement behaviour far from human performance. While walking and stair climbing at a comfortable pace was attained, the vast dictionary of motion primitives, allowing a human body to jump, play tennis, crawl, run, play the violin, and throw balls at a speed of 100 MPH, are unthinkable for the existing generation of humanoids. What's more, these systems are either small compared to human size or require large packs of batteries, allowing them to be active for several minutes—performing tasks with low dynamics!

As we will explain in the next section, one of the foremost properties of biological actuation, that of being able to *store* and *release* kinetic energy, is necessary to improve the dynamics of robotic systems. In biology, this property is taken over by muscle and, in some cases, tendon properties, implanting spring elements with variable spring and damping characteristics. Such spring elements allow for a very efficient interaction with the environment: high impacts can be reduced by storing energy in the springs, while high dynamics is reached by again releasing it. A human will, at worst, be bruised when running into a wall, stumbling, or high-impact hitting a rigid object; a stiff robot system will destruct or be destructed.

A related issue is *touch sensing*. For various, mainly technological, reasons, touch sensing has been mainly ignored in robotic systems until the first years of this century. The reason that no existing robotic hand can open a bra or light a match is not due to limited actuation capabilities, rather due to the limited sensing that is available. In order to obtain an interaction with the environment which is both based on high dynamics as well as gentle touching, an appropriate sensor – we can learn from biological skin – must be investigated and, where useful, adapted.

In the next three sections, the topics of actuation, sensing, and control in the context of robotic human systems will be evaluated on the basis of several examples.

## 2. Human-like actuation

In the design of robotic systems which should near human movement as closely as possible, a major task lies in the construction of actuators having properties similar to those of muscles. With the current status of technology, it is not yet possible to copy biology: no actuation systems, in the form of artificial muscles exist, which copy the essential properties of biological muscles. Which solution can be found? In this section, we will explain which essential properties of biological muscles we are aiming for, and which alternatives are currently under development.

Why are we aiming for muscle-like actuators? As explained in the introduction, our primary aim is the construction of robotic systems which can mimic human movement as closely as possible. Consequently, we must not only build systems with similar kinematics, but which also have the same *agility*: being able to react and move fast, but also to exert high forces, and handle high-energy impacts. These properties are closely related to muscle function, having a very high energy density while being flexible, allowing short-term storage of large amounts of energy (Section 2.1).

Building on the preferred actuation principles, a detailed kinematic study of the human hand (Section 2.2) will then bring us to the development of an integrated hand-arm system (Section

2.3), marking a first step in the construction of human-like robotic systems.

### 2.1. Muscles

Several properties of the biological muscle are essential for the dynamics of human limb movement as described above. First, a biological muscle has a force-to-weight ratio as well as force-to-volume ratio unmatched by current technical approaches. For instance, the whole human arm has an approximate 4:1 force-to-weight ratio; the best robotic systems can reach around 1:1. Secondly, maximal velocity, maximal acceleration, as well as very low latency movement onset are essential. Another aspect is the non-linear velocity-dependent damping. This is required for its wide range of operation, from repetitive movements requiring little damping (e.g., limb swinging during walking) to high-precision trajectory following (e.g., a surgeon doing precision cuts). Final important characteristics are elasticity and energy storage, which are essential both for safety and for executing high-dynamics movements. Kinetic energy can be stored in the muscles (see Fig. 3), to absorb impact energy, efficiency (e.g., during rhythmic walking motion) or release a large energy impulse (e.g., to throw a ball).

How can these properties essential for the control of human-like actuators be reproduced? The attempts so far have utilised pneumatics, smart materials, or modified electrical motor systems. Table 1 takes a look at a few of the basic properties of these systems as compared with human skeletal muscle tissue. The table examines the force densities and maximal velocities of each technology as these properties are key performance factors. It also includes power (coupling) efficiency and maximum displacement for the sake of brevity. All of the artificial methods can surpass human muscle in one area or another, but an advantage in one property is always counterbalanced by a loss in another. For instance, shape memory alloy (SMA) betters human muscle in both force density by weight and by volume, however, it can not achieve the required displacement nor a semblance of the required velocity and power efficiency.

A first approach consists of pneumatic actuators, such as the McKibben muscle which was commercialised in various implementations (Bridgestone; FESTO), and the Pleated Pneumatic Muscle implemented in a humanoid at Vrije Universiteit Brussel (Vanderborght, 2007). In both, a flexible resilient tube is inflated with pressured air, which shortens the length while expanding the diameter. The system provides a relatively good force-to-weight ratio and acceptable reaction times. In fact, this approach provides a force-to-weight and force-to-volume ratio which exceeds human muscle, as shown in Table 1. On the downside, however, it is difficult to precisely control the airflow, only reaches half the velocity of human muscle, and those force-to-weight and force-to-volume ratios are severely decreased once the compressors and valves are taken into account.

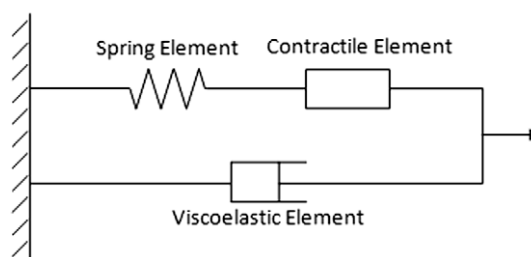

Fig. 3. Hill muscle model. Passive energy can be stored in the spring as well as in the viscoelastic elements.



**Table 1**  
Properties of biological and technical muscles.

Type	Force density (N/cm <sup>3</sup> )	Force density (N/kg)	Power efficiency (%)	Displacement (%)	Maximum velocity (mm/s)
<i>Properties of current artificial muscle technologies compared to human skeletal muscle</i>					
Human skeletal	2.98 <sup>e</sup>	2825 <sup>e</sup>	45 <sup>a</sup>	30 <sup>a</sup>	1115 <sup>j</sup>
Pneumatic (McKibben)	28.15 <sup>1,a</sup>	13,000 <sup>1,a</sup>	49 <sup>1,b</sup>	32 <sup>f</sup>	500 <sup>f</sup>
Pneumatic (pleated)	48–56 <sup>1,a</sup>	30,000–60,000 <sup>1,a</sup>	25 <sup>i</sup>	35 <sup>a</sup>	200–400 <sup>c</sup>
Electroactive polymer (acrylic dielectric) <sup>k</sup>	0.33	310	30–90	>100	10,000
Electroactive polymer (IPMNC) <sup>d</sup>	0.882	0.49	25–30	103	6.83 <sup>h</sup>
Shape memory alloy (BioMetal) <sup>g</sup>	22.2	3500	<10	4–8	180

<sup>1</sup> Data does not consider the weight and volume of the air compressor and valves just as data for electrically driven actuators does not consider the power supply, or human muscle data does not include the organs necessary to keep the muscle alive.

- <sup>a</sup> Daerden (1999).
- <sup>b</sup> Chou and Hannaford (1996).
- <sup>c</sup> Verrelst et al. (2000).
- <sup>d</sup> Shahinpoor et al. (2007).
- <sup>e</sup> Klein et al. (2001).
- <sup>f</sup> Klute et al. (1999).
- <sup>g</sup> Toki (2009).
- <sup>h</sup> Anton et al. (2006).
- <sup>i</sup> Vanderborght (2007).
- <sup>j</sup> Klute (1999).
- <sup>k</sup> Carpi et al. (2008).

An alternative approach is to use so-called smart materials. There are a several different types of smart materials, each characterised by its method of generating mechanical energy, or movement.

*Shape memory alloys* (SMA) are part of thermoresponsive materials. They convert a change in thermal energy (change in temperature) into a change in geometry due to changes in their crystalline structure. As an example, one available actuator is spring made out of SMA material. It will shorten and elongate when different temperatures are applied. This motion can be harnessed to lift a weight, act as a switch, and so forth. Although they offer a high force density and can contract by 8%, their applicability is limited due to very slow heating/cooling cycles, thus leading to low bandwidth as well as material fatigue.

A different type of smart materials is responsive to electrical changes, hence using electrical energy to generate movement. Among these are so-called piezoelectric ceramics. Similar to SMA, a mechanical deformation is caused in the crystal when an electric field is applied. But these materials are very fragile relative to sheer stress and have only micrometer elongation (Sinapius, 2007). Another type of smart material is the family of *Electro Active Polymers* (EAP). The applied electric field causes the polymers to bend and produce a lateral force. The elastic nature, their similar density to human muscle, high reaction time, and high power efficiency make EAPs a very promising material. They are still limited by their low force density and velocity (Shahinpoor et al., 2007).

A more conventional approach to generating a linear motion is to convert the rotary output of an electric motor by means of a leadscrew. Hence, the motor torque is translated into a linear force. These methods provide a constant force at a linear velocity determined by the thread pitch and the motor's radial velocity. This constant behaviour is radically different from the non-linear velocity-dependant damping found in human muscle, however, this system does have its advantages. In the example of a 50 mm DLR RoboDrive motor paired with a ballscrew, the complete system will operate at 75.6% power efficiency. As force-to-weight and force-to-volume ratios are highly dependent on the required velocity of the system, Table 2 compares the force densities across the range of velocities. As one can see, a rotary-to-linear system can only match the force density human when operating at roughly one third of the velocity, which coincidentally is also the maximum velocity as the system will self-destruct when pushed further. Numerous experiments have been conducted in adding elastic ele-

ments and damping to the system, but none have been completely successful yet.

To overcome the poor performance, new research is underway to combine smart materials and traditional solid materials. One example is a compressed spring covered by EAP material. While an electric field is applied the EAP material elongates and the spring relaxes. When the electric field is deactivated the EAP shortens, compressing the spring. A second example is a hydro gel pad embedded with multitudes of minuscule silicon needles. In a

**Table 2**  
Force density comparison between DLR RoboDrive and muscle.

Velocity (mm/s)	Force density (N/kg)	Force density (N/kg)
<i>RoboDrive 50 × 8 mm and ballscrew with 30% displacement</i>		
400	1178.37	2.22
300	3145.45	4.30
100	9436.34	12.90
<i>Human<sup>a</sup></i>		
1200	408.13	0.82
1100	445.23	0.89
1100	2825.00	2.98
1000	489.76	0.98
900	544.17	1.09
800	612.19	1.22
700	699.65	1.40
600	816.26	1.63
500	942.70	1.78
<i>McKibben<sup>1,b</sup></i>		
500	13000.00	28.25
<i>Pleated (high)<sup>1,b</sup></i>		
400	60000.00	56.00
200	4718.17	6.45
<i>Pleated (low)<sup>1,b</sup></i>		
200	30000.00	48.00
<i>Shape memory alloy<sup>c</sup></i>		
200	3500.00	22.00

Calculated values were based on datasheets on the Rockford Ball Screw and DLR RoboDrive. Data above 200 mm/s for the RoboDrive and ballscrew is only achievable at very large displacements. No ballscrew is capable of producing the acceleration to achieve >>200 mm/s withing the 5 to 7cm contraction distance of the human biceps brachii without catastrophic failure.

- <sup>a</sup> Klein et al. (2001).
- <sup>b</sup> Daerden (1999).
- <sup>c</sup> Toki (2009).

device resembling hairy skin, the needles stand erect when it encounters a humid environment.

The dream of constructing a near-natural artificial muscle may be realised by utilising nanostructures such as Carbon Nanotubes (CNT), cylinders of carbon molecules which deform when a field is applied to them. First results, published by [Baughman et al. \(1999\)](#), established proof of concept. Ten years later, CNTs are mere steps away from usable actuators ([Aliev et al., 2009](#)). They are now able to provide lateral displacements in excess of 200% and blocking stresses comparable to steel. Unfortunately, CNTs still require at least 1 kV to produce 30% displacement, not ideal for devices in close contact with a body.

As a conclusion of the conducted literature research, it can be stated that today no material or prototype exists which can provide the full spectrum of properties to allow for the application as an artificial muscle in robotic systems. The next section details the method DLR uses to update the classical approach to include dynamic elasticity, thus allowing for not only non-linear velocity-dependent damping, but an adjustable non-linearity at that. This actuation system, when combined with the mechanical model of the human hand (Section 2.2), allows for an artificial musculo-skeletal system (Section 2.3) a step closer to perfection.

### 2.1.1. The DLR approach

It is not unlikely that, on the long term, one of these – or adapted – approaches (Section 2.1) will lead to artificial muscle actuators which, with respect to their energy density and other properties, can compete with biological muscles. However, since the timeframe until the breakthrough is unforeseeable, we decided to follow a “classical” approach for our future robotic systems, based on brushless dc motors (the DLR RoboDrive motor) and high-ratio gears.

Due to their compact size and high force-to-weight ratio, dc motors are a more likely candidate for actuation in anthropomorphic systems. Most approaches consist of two motors working against (to increase stiffness) or with (to change position) each other and are connected over gear boxes via elastic elements. In most cases, these elastic elements consist of springs ([Koganezawa and Ban, 2002](#); [Koganezawa, 2005](#); [Migliore et al., 2005](#)). Since springs are linear, however, these alone do not suffice—increasing the force of a linear spring does not increase its stiffness. Therefore, such solutions have to include a mechanism changing the linear properties of the spring into a non-linear behaviour. Variable stiffness is necessary to accomplish different tasks, like those mentioned in the introductions to Sections 2 and 2.1.

There have been different approaches towards obtaining non-linear springs in the literature. [Morita and Sugano \(1995\)](#) used a spring leaf with varying length in order to induce nonlinearities on the spring. The construction, however, was difficult and error-prone, and led to a complex non-linear transfer function. [Migliore et al. \(2005\)](#) used a special spring device inducing a force–length relationship which can be determined by the curvature of a bar extending two springs. The construction is relatively large and may suffer from non-linear friction and wear-and-tear. [Tonietti et al. \(2005\)](#) introduced a variable stiffness actuator, a rather complex and large structure actuating three springs with tendons over rollers. [English and Russell \(1999\)](#) construct an antagonistic elbow joint using similar approaches as presented in this paper. However, in our approach the elbow actuators cannot be placed in the lower arm, since that space is needed for the hand actuators. Also, they assume that arm stiffness is independent of joint position, but that would lead to linear springs and remove the requirement of robustness against collisions, since the stiffness near the joint limit would not increase, as it does in our case.

Our concept follows the approach by [Tonietti et al. \(2005\)](#), but in a significantly simplified form. In our set-up, each motor is

equipped with a non-linear spring element (see [Fig. 4](#)). Each element consists of a linear spring which pushes the tendon, forming it into a triangle. The height of this triangle relative to half the base determines the stiffness of the construction. Two motors, each of which is equipped with a non-linear spring element, then can be used to increase the total stiffness (up to infinity) by pulling in counter directions, since their tendons are stiffly connected to each other via the joint that they are controlling.

## 2.2. Kinematic model of a human hand

As mentioned in the introduction and shown in the previous section on muscles, our approach to bionics is to model the functionality of the biological system and to (try to) attain it with feasible technological means. This also applies to the human and robotic hand, respectively. The enormous scope of functionality of the human hand is highly desirable for a robotic end-effector. Having a tool that is able to accomplish a range of tasks like: picking up a key, inserting and turning it and working the door latch; delicately holding an egg or firmly grasping a hammer, opens up a wide range of applications, from service robotics to prosthetics. Additionally to sensing (Section 3), capable kinematics (i.e. the way in which the finger joints are able to move) are essential for the mastering of such tasks. To fully appreciate and understand the human hand and to be able to use its kinematic principles, a precise analysis of a currently unsurpassed level of detail is required.

The main questions with respect to hand kinematics are, how many degrees of freedom (DoF) does each joint provide, and how are the joint axes oriented? Some answers can be given by just looking at one's own hand. For example, the interphalangeal (PIP and DIP) joints of the fingers seem to have one DoF, with axes roughly perpendicular to the bones, while the metacarpo-phalangeal (MCP) joints have at least two degrees of freedom. But how are the two MCP axes oriented? Are the axes of the PIP and DIP joints really perpendicular to the bones? (The little finger moves medially when flexed, which is impossible with perpendicular axes.) Furthermore, does the thumb carpometacarpal (CMC1) joint provide two or three degrees of freedom? Which joints are involved in arching the palm, and to what extent? In order to obtain answers to these questions, we carried out detailed research of human hand kinematics. The goal was to build a complete kinematic model of a human hand, including the number of DoF for each joint, as well as the exact positions and orientations of the joint axes. The joints of the thumb and of all fingers and the intermetacarpal (IMC) joints were modelled ([Fig. 5](#)).

The investigation was carried out in vivo on a healthy right hand of a 29-year-old female subject, whose finger bones were recorded by magnetic resonance imaging (MRI) while maintaining 1 of 50 different hand poses ([Fig. 6](#)). The recorded hand poses have been carefully selected, so that for each joint the extreme positions were covered, as well as some intermediate ones. Each image was

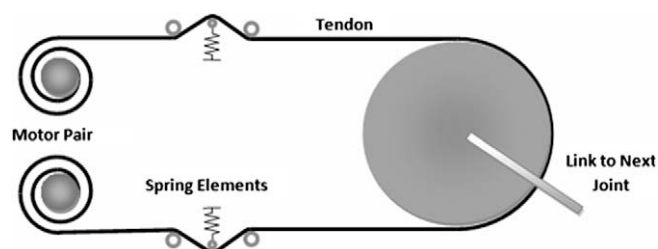

**Fig. 4.** Biarticulate control of a joint using non-linear spring elements. The height of the spring determines the stiffness constant.

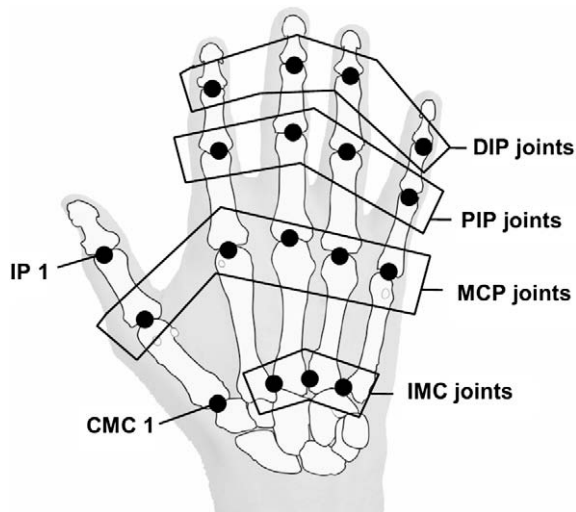

Fig. 5. Human finger joints.

thereafter manually segmented, thus extracting a point set of each bone.

Taking one image as reference image, the position and orientation of each bone in the other images can be determined numerically with respect to the reference. From this information, the relative motion of the bones around each joint is calculated.

Seven types of joint models are defined to be valid: 1-DoF, 1-DoF with two coupled axes, 2-DoF, 2-DoF with orthogonal axes, 2-DoF with non-intersecting axes, 3-DoF and 3-DoF with non-intersecting axes. The parameters of these joint models are then optimised numerically to fit the relative motions of the bones. The orientational and translational difference between the modelled and the measured pose is used to determine the type of each

joint – 5° average orientational and 3 mm average translational error is taken as tolerance boundary. The simplest joint type fulfilling this boundary is then chosen.

The resulting kinematic model has 27 degrees of freedom as shown in Fig. 7. The positions of the joint axes are marked by dots and the orientations are shown as arrows. All joints have either one or two degrees of freedom, whereas in joints with two DoF, the first axis is marked “1” and the second axis is marked “2”. The first axis stays fixed with respect to the proximal bone, while the second axis is fixed to the distal bone.

The joint axes of all the 2-DoF joints intersect, except for the axes of the thumb CMC joint, where they fall apart from each other by 21 mm. The first axis of CMC1 is the flexion/extension axis; it runs through the base of the thumb metacarpal. The second axis is for abduction/adduction and passes just below the base of the index finger metacarpal. Comparing the model of the CMC1 joint to the findings of Hollister et al. (1992), who investigated seven cadaver hands, there is some consensus and some contradiction. There is consensus that the axes are apart. However, Hollister et al. (1992) found the abduction/adduction axis running through the thumb metacarpal and the flexion/extension outside the thumb metacarpal. This implies slightly different behaviour of the thumb. The reason for this discrepancy could be that Hollister et al. (1992) measured the movement of the thumb metacarpal bone with respect to the adjacent trapezium bone, while here the movement was determined with respect to the index finger metacarpal.

All metacarpal joints are modelled as 2-DoF joints with intersecting axes and most of the interphalangeal joints are modelled as 1-DoF joints. The IMC joints are also modelled as 1-DoF, with axes in the longitudinal direction of the metacarpals.

Rather surprising are the joint types of the thumb and little finger interphalangeal joints. All are modelled with 2-DoF, contrary to the expected 1-DoF. Anatomically, however, there can only be one active DoF in each of these joints, because only one pair of tendons is connected with each of the corresponding bones. The modelled



Fig. 6. MRI images of the hand in different poses.

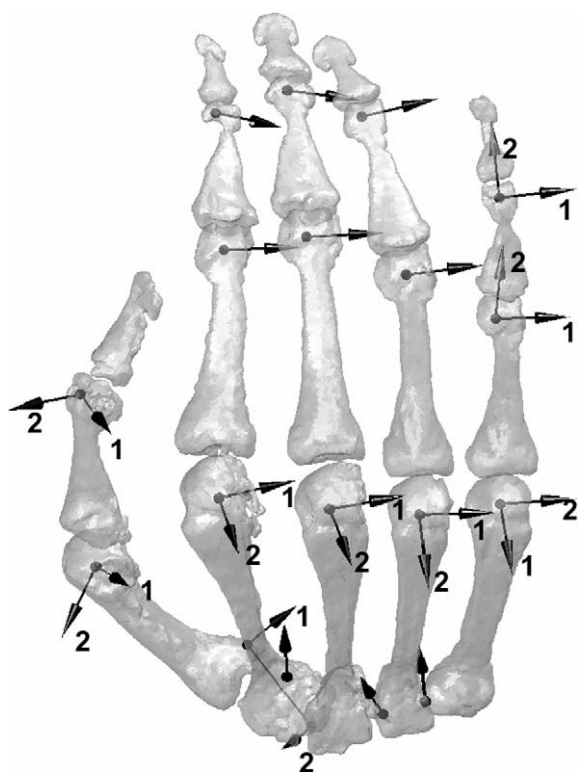

Fig. 7. DLR's kinematic model of the human hand.

second DoF of the interphalangeal joints is probably due to imprecisions in the estimation of the bone orientations or to *passive* movements of the bones.

### 2.3. An integrated hand–arm system

Many of the methods and approaches explained in this paper are integrated in a first prototype of a new generation of robots. These robots, which we are currently realising in the form of an integrated hand–arm system, should come as close to human agility as technically possible. But rather than to copy its intrinsic structure, our goal is to closely copy the properties of the hand. The solutions found in biology must be transferred to technical components and evaluated before they can actually be used.

As explained in Section 2.1.1, we decided to introduce variable passive compliance into future robotic systems.

The system (Fig. 8) is designed as a fully integrated hand–arm system, consisting of an antagonistically actuated hand with all its drives in the attached forearm, a 2-DoF wrist, a 2-DoF elbow and a 3-DoF shoulder.

#### 2.3.1. Anatomy of the hand

The analysis of the human hand (as described in the previous Section 2.2) together with results found in the literature (Kapandji, 1998; Benninghoff and Drenckhahn, 2002; Kuczynski, 1975) and the knowledge resulting from the development of our former robotic hands form the basis for our robotic system (for details, see Grebenstein and van der Smagt, 2008).

The structure of the finger is designed as an endoskeleton with bionic joints (Fig. 9). The carpometacarpal joint of the thumb is designed as a hyperbolically shaped saddle joint. Also the metacarpal joints of the fingers are, in contrast to biology, designed as hyperboloid joints. This circumvents the negative side effects of technical condyloid joints. To reduce the complexity of the system the metacarpal joint of the thumb is designed as a one DoF hinge joint

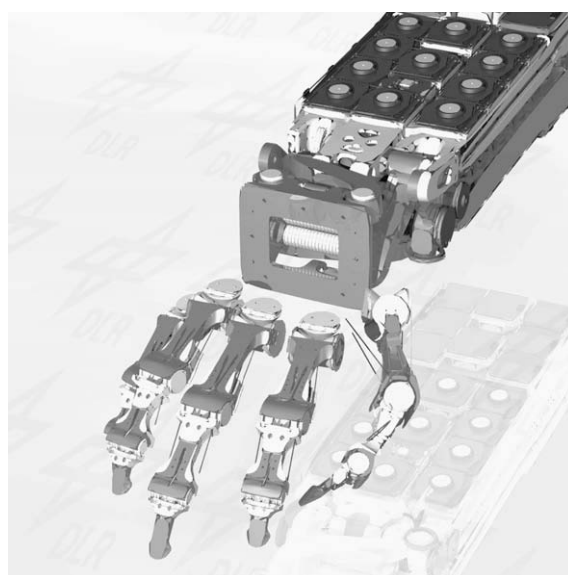

Fig. 8. Rendering of DLR's hand–arm system.

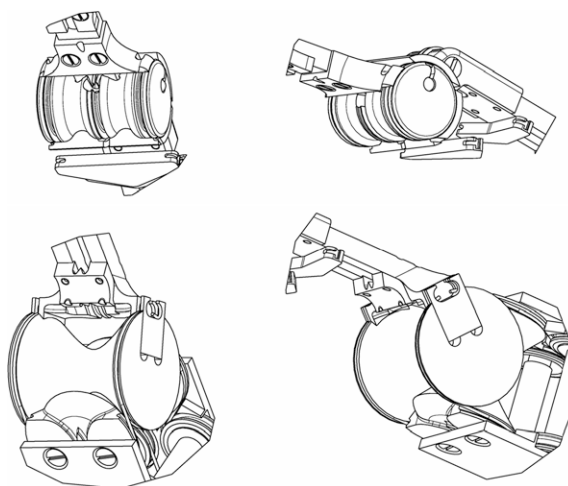

Fig. 9. Biologically inspired overload-proof joint.

since leaving out the thumb's fifth degree of freedom is not problematic (Kapandji, 2006). The interphalangeal joints are also designed as hinge joints. The kinematics of the new hand is closely adapted to the human hand. So every finger differs in “bone”-length, size and kinematics. All joints enable dislocation of the “bones” without damage in case of overload, using the elasticity in the drive train.

In addition to the known assets, such as robustness and short-term energy storage, the use of antagonistic actuation enables us to cope with geometric inaccuracy which is one of the major problems of known tendon-driven mechanisms. In contrast to standard tendon routed systems with inherent constant tendon length, unaligned pulley-axes and other geometrical errors do not overstretch or slacken the tendons, since these inaccuracies are compensated by the elastic elements in the drive train. Therefore, no tendon tensioner is needed.

A fully functional finger prototype was built and used to validate the concepts and optimise the finger construction (Figs. 10 and 11).



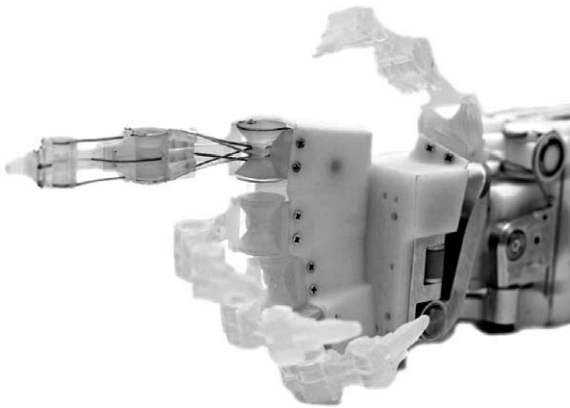

Fig. 10. Mockup of hand with final index finger design.



Fig. 12. Wrist integrated in forearm mockup.



Fig. 11. Final hand design virtually grasping a 0.51 glass.

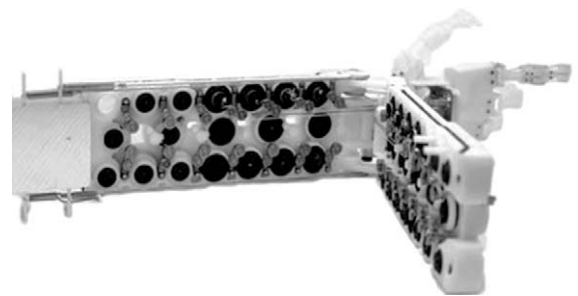

Fig. 13. Inside view of forearm mockup with opened base frames.

maintenance of tendons, springs and other parts. They also hold the water-based cooling channels to keep the system thermally stable, even during operations which require high strength for a prolonged period (Fig. 13).

### 3. Human-like sensing

This section will focus on a single, central, aspect of sensing in humans: that of touch sensing. Touch and haptic sensory inputs are crucial and fundamental to the sensorimotor tasks in our everyday behaviour. Although we traditionally think of losing ones sight as the most dramatic form of sensory loss – this is because of its frequency of occurrence. Medical history lists a case in which a 19-year old man lost proprioception and touch sensation below the neck as a result of a viral infection. It took him a year to learn to walk and move again and although he can now perform many motor tasks, it comes only at the cost of inefficient cognitive input.

Nevertheless, human-like touch sensing is not matched in robotic systems. Even though existing robotic hands include various sensors, they do not deliver contact information with a satisfying spatial resolution (Butterfass et al., 2004; Lovchik and Diftler, 1999) or the sensors are not flexible (Kawasaki et al., 2002) and thus complicate fine manipulation tasks.

Apart from the fact that the importance of human-like sensing is only emerging for newer generations of robotic systems, its technical challenge is enormous. Take the human index finger as an example: within an area of approx.  $1 \times 1$  cm, our two-point spatial separation is around 1 mm, and we have four or five orders of magnitude of touch sensitivity, while being able to sense forces in three directions. Not counting surface, shape, vibration, and temperature sensing. Is there a way of creating a robotic sensor with similar properties, at similar size?

#### 2.3.2. Wrist and forearm

To reduce friction by keeping the angle of tendon deflection minimal, as well as to downsize coupling between wrist and finger motion, a 4-bar mechanism wrist, forming a 3-D anti-parallelogram, has been developed (Fig. 12). It enables routing the tendons as close to the neutral position as possible and in addition centres and therefore stabilises the wrist if maximum tension (totalling  $>6$  kN) is erroneously applied to the tendons. The wrist is actuated by 4 mini servo units located between the elbow and forearm base frames.

Since the hand itself has no drives or electronics, these have to be integrated into the forearm. To realise antagonistic drives for the total of 19 DoF (4 DoF thumb, index, middle finger, 3 DoF ring finger, and 4 DoF 5th finger), 38 actuators, 38 elastic elements, 38 motor position sensors and in addition 38 sensors measuring the deflection of the elastic elements have to be located in the forearm. These actuators are realised as mini servo units consisting of motor (DLR's ILM25), gear, and non-linear elastic element. All required sensors and electronics are integrated into the "mini servo unit". A high-resolution angular rotor position sensor has been realised as well as an angular magnetoresistive sensor to measure the deflection of the elastic elements lever.

The "mini servos" are integrated into two base frames which are connected at the base of the wrist and can be separated for easy

### 3.1. A bio-inspired sensor setup

The ultimate goal of a biologically inspired touch sensor is to allow manipulation capabilities competing with those of humans. A number of requirements follow from this goal. First of all, it requires compliance similar to human skin in order to improve grasping of small and structured objects. Furthermore, a high level of sensitivity and a high spatial and temporal resolution is required. At the same time the skin has to stand very high forces and abrasive objects. While human skin is constantly replaced by proliferation of skin cells, artificial surface sensors have to be equipped with a replaceable protective layer. Further requirements result from the technical side, e.g. a monotonic output, a high dynamic range and, low hysteresis.

Our targeted application in the integrated hand–arm system (see Section 2.3) adds a few technical requirements. To enable the application of the artificial skin on the fingertips it has to be stretchable and offer a large surface compared to the number of necessary readout wires. The high mechatronic integration results in very limited designed space for the skin and its readout electronics.

Combining these requirements, a number of conflicts arise. How are these conflicts solved in nature? As shown in Fig. 14, the human skin consists of different layers containing different types of sensory cells in different depths. These sensory cells are optimised for the detection of different modalities of the mechanical stimulus. We employ this strategy in our sensor, which consists of a “dermal” and a superficial layer.

While the “dermal” sensor is based on metal readout wires cast into a compliant piezoresistive material, the superficial sensor is designed as a strain sensitive layer covering the “dermal” sensor. An interchangeable protective layer covers the superficial sensor (Fig. 15).

Currently the different sensor systems and the required manufacturing processes are under investigation. Fig. 16 shows a prototype of the “dermal” sensor. This sensor provides 25 tactile elements (taxels) at a spatial resolution of less than 1 mm, comparable to the human fingertip. Future work will aim towards the development of the superficial sensor as well as to the integration of the readout electronics.

Fig. 17 shows the readout of the sensor patch if indented with the above indenter. Different indentors have been applied to demonstrate the discriminatory capabilities of the “dermal” sensor. Future work will aim towards the development of the superficial sensor as well as to the integration of the readout electronics.

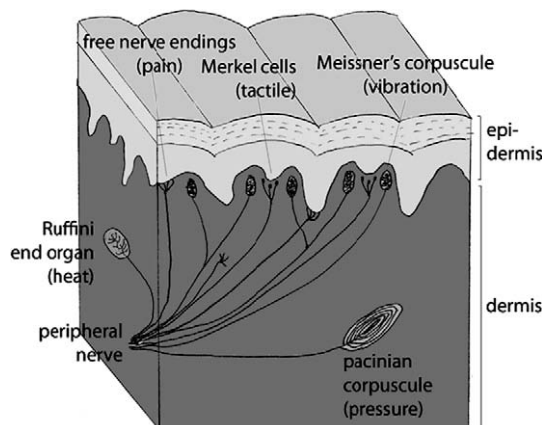

Fig. 14. Sensory cells in human skin.

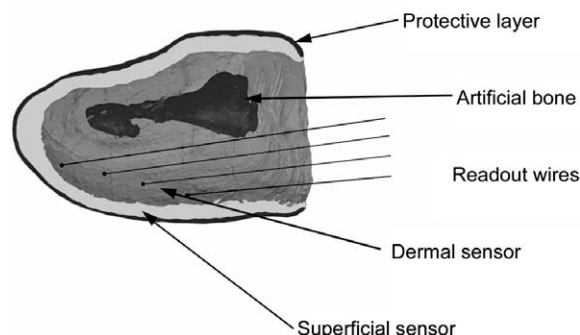

Fig. 15. Bio-inspired sensor setup.

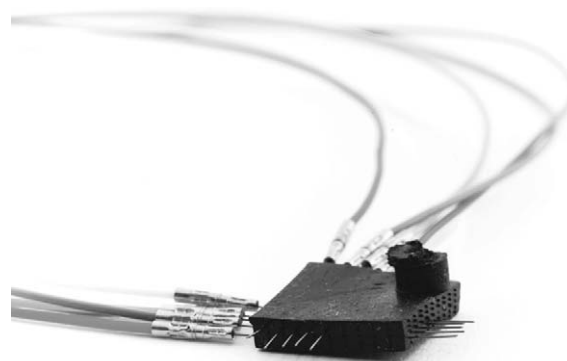

Fig. 16. 11 × 11 mm prototype of the “dermal” sensor.

## 4. Human-like control

We will round up our excursion by listing several approaches to biologically inspired control. There are several levels of control that we have to study in biological systems, from muscle activation (in robotics, motor control) to voluntary and reflexive body movements. Motor control is directly related to the type of actuator that is used, and hence outside the scope of this paper; indeed, in our case, in which we use brushless dc motors, classical motor control plays a prominent role. Of major interest is how muscle function is used in determining, e.g., the stiffness of a joint during operation, the planning of a trajectory during voluntary movement, and the mechanisms involved. We will cover those issues in the following sections. In Section 4.1, our results with using EMG for determining finger movement and grasp force are explained. Section 4.2 shows our findings on the voluntary movement of the human arm during ball catching experiments. In Sections 4.3 and 4.4, models of the underlying control mechanism are given.

### 4.1. Using EMG for human in the loop control

Advances in mechatronics enable the development of highly dexterous, yet reasonably small and light weight robots to be used in human environments. A big challenge of robotics is to make these robotic devices controllable by the human in an intuitive way. Surface Electromyography (EMG) seems to be a very promising way to approach this problem. It provides a simple and non-invasive method for a human–robot interface, and first implementations are already working. Nevertheless, there is a lot of room for further research.

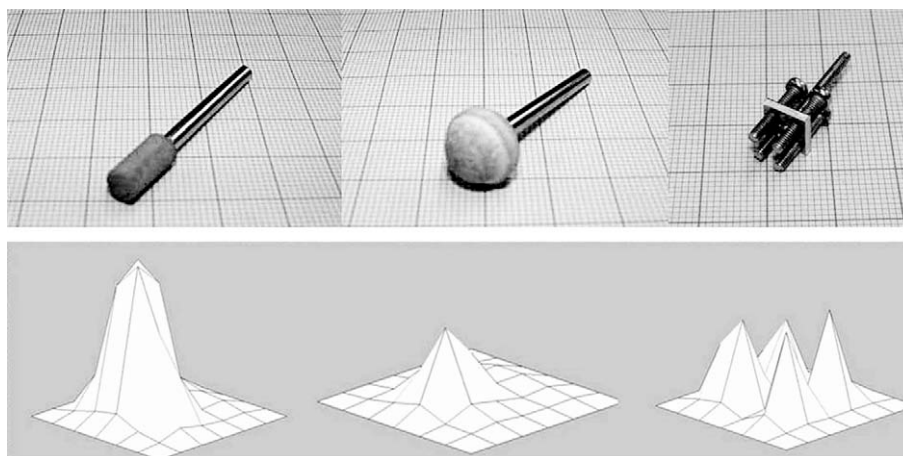

Fig. 17. Readout for different indentation probes: cylindrical; spherical; 4-point-indentor.

Up to date, EMG in robotics devices is mainly used to control hand prosthesis in a fairly simple way, whereas, Otto Bock's SensorHand (OttoBock, 2008) and Touch Bionic's i-Limb (TouchBionics, 2007) are amongst the most dexterous available devices. The SensorHand has only one DoF for opening and closing the hand, without offering the patient an intuitive way of commanding a force. Typically it is controlled by the use of two EMG electrodes. The i-Limb, technically offering five independently moving fingers, is controlled by only two EMG electrodes, and neither offers the patient any fine control over the fingers, nor a possibility to control the actuated force. More advanced prosthetic hands are being developed in many places, including the CyberHand (Dario et al., 2002) and our DLR prosthetic hand (Huang et al., 2006).

The increasing capabilities of these new prostheses require more sophisticated methods to provide the user with the full range of possibilities, including the control of individual fingers and of the exerted force. Therefore, we are currently working on refining the available EMG based controls.

By applying 10 instead of 2 commercially available EMG electrodes (13E200 = 50 surface EMG electrodes by Otto Bock), we already demonstrated that EMG is a valid tool for controlling a robotic device (Bitzer and van der Smagt, 2006; Maier and van der Smagt, 2008).

Placing these 10 electrodes on the forearm of a healthy subject (Fig. 18), the following 12 finger/hand postures can successfully be discriminated: extension and flexion of the thumb, index finger, middle finger, and ring/little finger, respectively; power grasp; glo-

bal finger abduction/adduction; rest. However, this is a strict classification method, so no gradual changes between or mixtures of these postures are detectable. For classification we use support vector machines (SVM) (Schoelkopf and Smola, 2002), a robust mathematical classification tool, and some pre-processing of the raw EMG-signals like wavelet transforms, shape of the peak, timing of the peaks in relation to the other electrodes and others. This method requires a training phase for each user and each time it is used: First, the exact placement of the electrodes varies by reapplying the electrodes, and secondly, the muscular anatomy differs from person to person. Our methods were successfully applied (Bitzer and van der Smagt, 2006; Maier and van der Smagt, 2008) to robotic devices by controlling two different DLR robotic hands, the DLR Hand II (Butterfass et al., 2004) and the DLR-HIT hand (He et al., 2004).

As a next step, we investigated the possibility of recognizing the exerted force for a specific grasp type. A SVM was applied to the raw EMG data to classify the used grasp type (index finger pinch grasp, middle finger pinch grasp, power grasp and the "no grasp" or idle state). In parallel, however, a feed-forward neural network with one hidden layer was used to estimate the exerted force, again using the raw EMG data. Again, 10 Otto Bock EMG electrodes were used; during training, the exerted finger force was measured at the finger tip for different pinch and power grasps. After training, the system's normal performance is about 90% correct classifications for the grasp type, and about 7.89% normalized root mean



Fig. 18. Placement of the EMG electrodes on the forearm. From Maier and van der Smagt (2008).

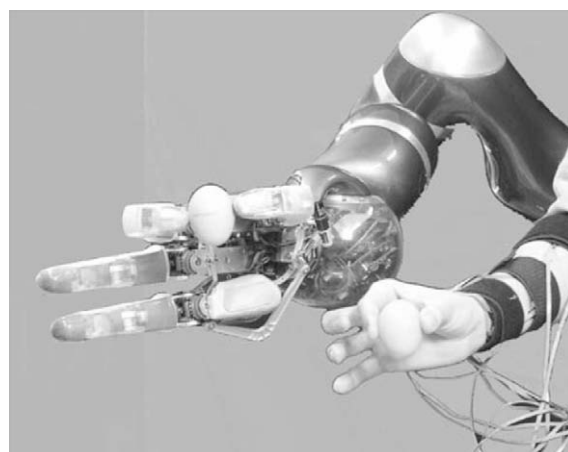

Fig. 19. DLR Hand II holding an egg without breaking it, controlled by EMG.



square error (NRMSE) for the grasp force, which translates to about 4.5 N error at 57 N maximum force. This method was also applied to both robotic hands, the DLR-HIT hand and the DLR Hand II, the latter demonstrating even the handling of delicate objects including eggs (Fig. 19) (Castellini and van der Smagt, 2009).

#### 4.2. Ball catching

Furthermore, we are interested in a principle for generating human-like 3D motions for everyday tasks. To better understand these principles we executed catching experiments with humans. Previously (Frese et al., 2001) we reported on a robotic ball catcher, based on the DLR Light-Weight Robot III and the four-finger hand II. The developed system can catch human-thrown balls at a high success rate, based on a series of technical approaches with respect to visual tracking, extrapolation, trajectory following, and grasping. Thus, catching experiments served two aims: Catching is a natural movement which combines fast movements and high accuracy at the interception point and we can investigate whether a human-like ball catching strategy offers any enhancements. So we developed a human-like catching strategy for our robotic ball catcher.

One possibility to generate human-like behaviour is to track human movements and save them in a look-up table, similar to Riley and Atkeson (2002) with their 30 degrees of freedom (DoF) robot. They aim to generate human-like behaviour for virtual robots and humanoids. Our aim is not only to make robots and robotic movements look human-like, but also to understand the principles behind human movement and to apply them to our robotic systems. For the catching experiments 11 right-handed persons were tracked while catching a tennis ball. To ensure equal trajectories of the ball a catapult was used. The ball was thrown from three different positions.

The results show that the tangential velocity profile of the hand is bell-shaped and that the hand movements coincide with the well known results for 2D point to point movements, in particular the minimum jerk theory (Flash and Hogan, 1985) and the 2/3 power law (Lacquaniti et al., 1983). Therefore we decided to use 3D minimum jerk to generate point-to-point movements with our robotic system. Furthermore, the two phases of fast reaching and slower fine movements at the end of the placement (Jeannerod et al., 1995; Dessing et al., 2005) can clearly be seen.

Fig. 20 shows the two different movement types: technical robotic and human-like robotic during ball catching. While the technical approach is to accelerate as fast as possible and move then with nearly constant maximum velocity, the human-like movement is smoother and more energy efficient.

#### 4.3. Micro movements

A completely different approach to Section 4.2 is generating goal based movements based on so-called micro movements (Gross et al., 2002). A micro movement is a short synchronous burst of muscle activity, forming a torque pattern to all involved joints. Literature suggests that a single micro movement will last about <100 ms, stemming from a cerebello-thalamo-cortical loop (Gross et al., 2002). The ~10 Hz frequency in movements can as well be found in other research, concentrating on small corrective movements (aka submovements), following the initial ballistic movement phase (Novak et al., 2002). For instance, pointing movements need up to three corrective submovements until the goal position is reached.

We plan to implement a model of the cerebello-thalamo-cortical loop (see Fig. 21). The frontal lobe is thought to deliver some kind of plan, e.g., to reach for an object, which will serve as a goal for a complex movement. In the premotor cortex (PMC) and/or the supplementary motor area (SMA), this coarse goal may be split up

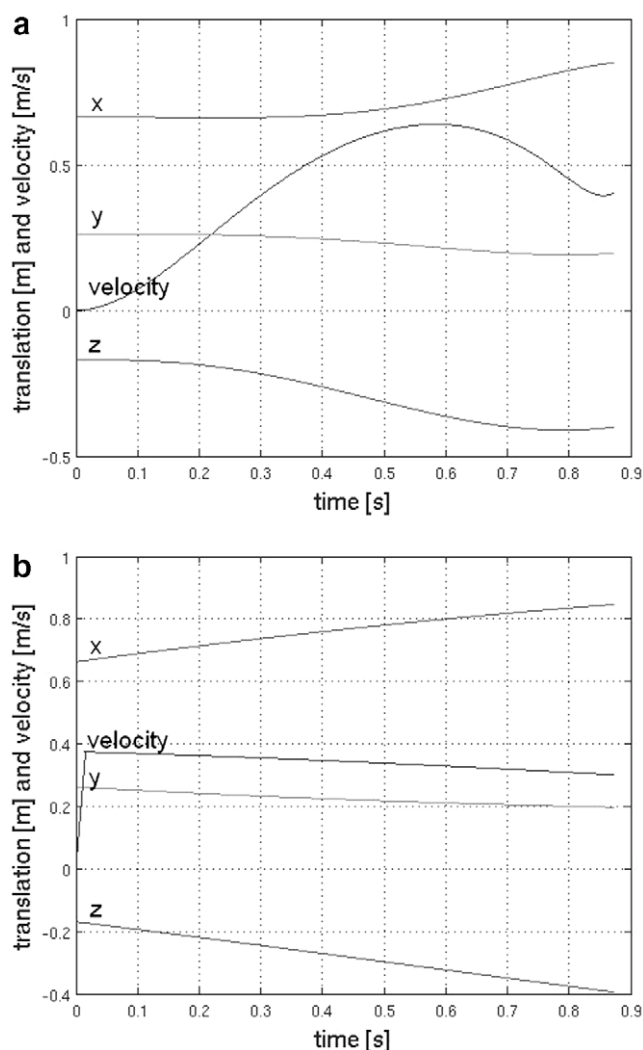

Fig. 20. Catching movement in x, y and z direction and tangential velocity of the hand for (left) the human-like and (right) purely technical catching strategies.

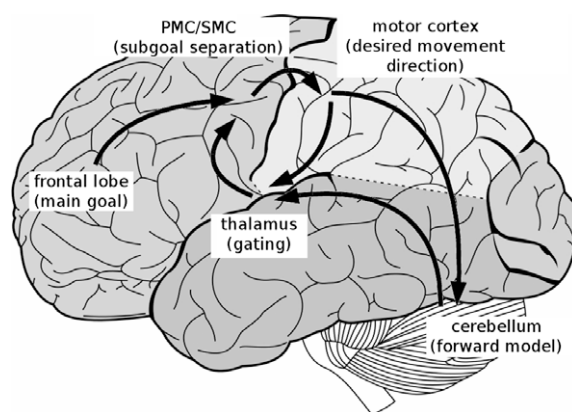

Fig. 21. Information flow for voluntary movements (after Gross et al. (2002)).

into suitable subgoals (Rizzolatti et al., 1990), which in turn are projected into the motor cortex, where, e.g., the desired end effector movement direction is available as population coding (Gazzaniga et al., 1998).

In the next step, each of the subgoals is subsequently divided in a number of micro movements. Assuming that an internal



movement predictor (i.e., a forward model of the skeletomuscular system) is available, preselected micro movements are applied within the model, and the result is compared (without actually executing the movement) with the desired movement direction found in the motor cortex. The result of a sequence of such optimisation steps, i.e., a set of subsequent micro movements, is then passed to the motor neuron system. The required gating facility seems to exist in the basal ganglia (Gazzaniga et al., 1998), which may promote the most responding, i.e., the locally optimal micro movement to the motor system. Several literature sources suggest that the cerebellum may serve as a feed-forward predictor for skeletomuscular dynamics (see below).

For a given type of movement not all possible combinations of torque applications are used by humans, but only a small selection. As other researchers suggest by recording human daily movements and applying dimensionality reducing algorithms onto this data, the intrinsic dimensionality of these movements is quite low (Vijayakumar et al., 2005). Therefore, a reduced set of torque distributions might be found that suffices to perform the given task—this reduced set is called a Micro Movement Set. Of course, each Micro Movement Set is task dependent, therefore a unique Micro Movement Set exists for each task, or class of tasks.

#### 4.4. The role of the cerebellum

As described in the previous section, the cerebellum possibly plays an important role in human muscle control, and might, when better understood, be used as a model for robot control. Nearly 2000 years ago, the participation of the cerebellum in muscle control was already postulated by the Greek gladiator surgeon Galen of Pergamum. To date, however, its precise involvement, e.g., on whether it stores forward or inverse models of the skeletomuscular system, is controversial. The first computational models published were based on the Marr–Albus model of cerebellar plasticity (Marr, 1969; Albus, 1971). First results in robotic applications of cerebellar systems were based on Albus' (1975) Cerebellar Model Articulation Controller (CMAC) model. Even though many derived or extended cerebellar models have been published since then, the authors are not aware of any single cerebellar model involved in the successful control of the dynamics of a nontrivial robotic system.

Singular to all of these approaches is that, as in a robotics environment, the cerebellum is interpreted and used as a stand-alone dynamics controller. This approach is very contrary to what is found in biology: here, the different aspects in the control loop are computed in different parts of the nervous system. We share the view that actions (see Section 4.3) are determined in the cerebral cortex, while the cerebellum provides a side-path which compensates for control delays and cerebral model aberrations. Recent investigations suggest different roles of the cerebellum in the control loop; including its interpretation as low-level velocity controller. This view is supported by cerebellar lesion studies, which usually shows patients who can perform any task, but not accurately or swiftly. Consequently, in considering the cerebellum as a part of a robotic control loop, it must be analysed of how control delays and nonlinearities are handled. Within this perspective, cerebellar structure and function will be very helpful in the control of a new class of highly antagonistic robotic systems as well as in adaptive control.

As robotic systems move towards their biological counterparts, the control approaches can or must do the same. It be noted that the drive principle that is used to move the joints does not necessarily have a major impact on the outer control loop. The control approach at the cerebellar level is independent of the actuator used. Of key importance, however, are the actuator-dicted dynamical properties of the system. As mentioned before, biological sys-

tems are immensely complex, requiring large groups of muscles for comparatively simple movements. A reason for this complexity is the resulting nearly linear behaviour, which has been noted for, e.g., muscle activation with respect to joint stiffness (Osu and Gomi, 1999). By this regularisation of the complexity of the skeletomuscular system, the complexity of the forward model stored in the cerebellum is correspondingly reduced.

At this instant, control of flexible robotic systems remains within the realm of classical control, which seem to be optimally coping with the added flexibility. An unsolved problem to date is the addition of an extra degree of freedom per joint: not just the torque of a joint must be determined, but also its stiffness is a free parameter. It is likely that cerebellar models can be a good path to follow when dealing with this increased complexity.

## 5. Extrodution

The goal of recreating a robotic system to copy human motion behaviour is an ambitious one, and in the above we have demonstrated several aspects thereof: what is the current state-of-the-art with respect to actuation, sensing, and control using approaches leaning on biology. Even though many of the components are required for the construction of our hand–arm system, we have also seen that, in many cases, we have to live with suboptimal solutions. Nonetheless a few example applications, as listed below, clearly demonstrate the applicability of the path we are following.

The ultimate goal, nonetheless, remains reconstructing the agility of the human body, be it with respect to walking and running, fine manipulation, or high-dynamic movements. It goes without saying that, apart from the design and construction of an artificial body that can realise these movements, high-level control (“cognition”) is required to deal with it.

### 5.1. Applications

In the previous sections, we have laid down paths for the development of the next generation of robotics, aiming at the task of assisting or, in hazardous environments, replacing humans. To this end, we study the human body and behaviour from a technical point of view. We thus also open up a new field of application with respect to rehabilitation and prosthetics. In the sequel, we will highlight these two short-term applications.

### 5.2. Rehabilitation

Stroke patients, suffering from paralysed extremities, or patients with replanted hands, have to relearn how to use their muscles to move (control) their hands and arms. Such physiotherapist-based therapy is very cost-inefficient, which often leads to suboptimal healing. We therefore investigated EMG-based hand rehabilitation methods (Maier and van der Smagt, 2008). As described in Section 4.1, we can use EMG signals to control a robot hand correspondingly. In the rehabilitation application, we used the DLR 4-finger-hand II, which is about 1.5 the size of the human hand, as an exoskeleton. Attaching the patient's fingers to the robotic hand, we could then have the patients train their own hands (see Fig. 22). The idea is to have the patients investigate the control of the rehabilitation device, which can then be filtered as desired. The desired muscle activity can be mapped on the desired finger movement – even if the actual intention of the patient is different.

### 5.3. Prosthesis

The focus on the properties of prosthetic robotic hands is currently undergoing a slow but steady shift. Whereas the cosmetic

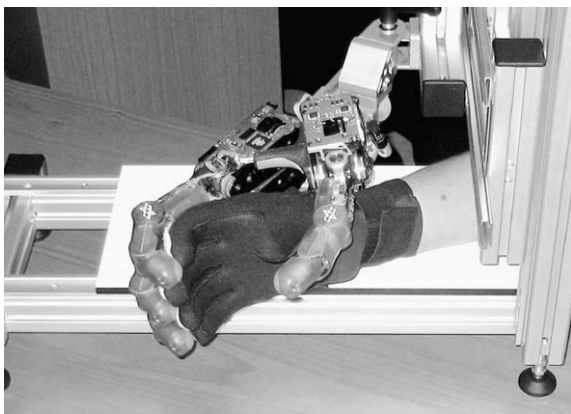

**Fig. 22.** Attaching the human hand to the DLR Hand II for rehabilitation purposes. From Höppner (2006).

aspect traditionally was and still remains an important issue for most patients, regained dexterity becomes more prominent as advances in mechatronic systems offer such possibilities. Consequently, most prosthesis manufacturers (e.g., Otto Bock, Motion Control, Liberating Technologies), besides their line of cosmetic hands, also offer a line of active hands. Such hands are controlled over EMG interfaces, measuring the activity of the patient's muscles (their motor units) in the lower arm. Such active hands however suffer from low acceptance among patients with amputated hands. One reason for this is the limited dexterity that such hands offer to the patient: with only one active degree of freedom, the hand can only open and close on command, and can thus only be used for very coarse grasping and handling. Whereas already many highly integrated prosthetic hands are under development or at production level (e.g., the DLR prosthetic hand or the Fluid hand), control of such hands using non-invasive interfaces is still problematic and cannot be used on patients. This problem is twofold: first, control of the finger movement (position and force) by the patient; as we have shown before, EMG is an appropriate interface. Second, the feeding back of prosthesis proprioceptive (e.g., contact with the environment, or output of the touch sensor) information to the patient. To date, this problem is not yet sufficiently solved. Long-term, neural implants in the patient's peripheral nervous system (e.g., in the stump of the lower arm) seem most promising, but the outcome of that line of research is still unsure. What's more, invasive approaches always have a limited impact factor, therefore non-invasive approaches have to be taken into account.

## References

- Aliev, A.E. et al., 2009. Giant-Stroke superelastic carbon nanotube aerogel muscles. *Science* 323, 1575–1578.
- Albus, J.S., 1971. A theory of cerebellar function. *Mathematical Biosciences* 10, 25–61.
- Albus, J.S., 1975. Data storage in the cerebellar model articulation controller (CMAC). *Journal of Dynamic Systems, Measurement and Control, ASME* 3, 228–233.
- Anton, M., Kruusmaa, M., Aabloo, A., Punning, A., 2006. Validating usability of ionomeric polymer-metal composite actuators for real world applications. In: *Proceedings of the IEEE/RSJ International Conference on Intelligent Robots and Systems, Beijing*, pp. 5441–5446.
- Baughman, R., Cui, C., Zakhidov, A., Iqbal, Z., Barisci, J., Spinks, G., Wallace, G., Mazzoldi, A., De Rossi, D., Rinzler, A., Jaszchinski, O., Roth, S., Kertesz, M., 1999. Carbon nanotube actuators. *Science* 284 (5418), 1340–1344.
- Benninghoff, A., Drenckhahn, D., 2002. *Anatomie. Makroskopische Anatomie, Histologie, Embryologie, Zellbiologie, Bd 1*. Urban & Fischer at Elsevier, Munich.
- Bitzer, S., van der Smagt, P., 2006. Learning of EMG control of a robotic hand: towards active prostheses. In: *Proceedings of the IEEE International Conference on Robotics and Automation 2006, Orlando, FL, USA*, pp. 4179–4186.
- Butterfass, J., Fischer, M., Grebenstein, M., 2004. Design and experiences with DLR hand II. *Proceedings of the World Automation Congress* 15, 105–110.
- Castellini, C., van der Smagt, P., 2009. Surface EMG in advanced hand prosthetics. *Biological Cybernetics*.
- Carpi, F., De Rossi, D., Kornbluh, R., Pelrine, R., Sommer-Larsen, P. (Eds.), 2008. *Dielectric Elastomers as Electromechanical Transducers*. Elsevier Science, pp. 1425–1442.
- Chou, C.P., Hannaford, B., 1996. Measurement and modeling of McKibben pneumatic artificial muscles. *IEEE Transactions on Robotics and Automation* 12, 90–102.
- Daerden, F., 1999. *Conception and Realization of Plected pneumatic Artificial Muscles and their Use as Compliant Actuation Elements*. Ph.D. Dissertation, Vrije Universiteit Brussel.
- Dario, P., Micera, S., Menciasci, A., Carrozza, M.C., Zecca, M., Steigltz, T., Oses, T., Navarro, X., Ceballos, D., 2002. CYBERHAND – a consortium project for enhanced control of powered artificial hands based on direct neural interfaces. In: *33rd Neural Prosthesis Workshop, Bethesda, MD, USA*.
- Dessing, J.C., Peper, C.E., Bullock, D., Beek, P.J., 2005. How position velocity and temporal information combine in the prospective control of catching: data and model. *Journal of Cognitive Neuroscience* 17 (4), 668–686.
- English, C.E., Russell, D., 1999. Implementation of variable joint stiffness through antagonistic actuation using rolamite springs. *Mechanism and Machine Theory* 34, 27–40.
- Frese, U., Bäuml, B., Haidacher, S., Schreiber, G., Schäfer, I., Hähle, M., Hirzinger, G., 2001. Off the shelf vision for a robotic ball catcher. In: *Proceedings of the International Conference on Intelligent Robots and Systems*, pp. 1623–1629.
- Flash, T., Hogan, N., 1985. The coordination of arm movements: an experimentally confirmed mathematical model. *Journal of Neuroscience* 5 (7), 1688–1703.
- Gazzaniga, M.S., Ivry, R.B., Mangun, G.R., 1998. *Cognitive Neuroscience, the Biology of the Mind*. W.W. Norton & Company, New York.
- Grebenstein, M., van der Smagt, P., 2008. Antagonism for a highly anthropomorphic hand-arm system. *Advanced Robotics* 22, 39–55.
- Gross, J., Timmermann, L., Kujala, J., Dirks, M., Schmitz, F., Salmelin, R., Schnitzler, A., 2002. The neural basis of intermittent motor control in humans. *PNAS* 99 (4), 2299–2302.
- He, P., Jin, M., Yang, L., Wei, R., Liu, Y., Cai, H., Liu, H., Seitz, N., Butterfass, J., Hirzinger, G., 2004. High performance DSP/FPGA controller for implementation of HIT/DLR dexterous robot hand. In: *Proceedings of the IEEE International Conference on Robotics and Automation*, pp. 3397–3402.
- Hollister, A., Buford, W.L., Myers, L.M., Giurintano, D.J., Novick, A., 1992. The axes of rotation of the thumb carpometacarpal joint. *Journal of Orthopaedic Research* 10, 454–460.
- Huang, H., Jiang, L., Zhao, D.W., Zhao, J.D., Cai, H.G., Liu, H., Meusel, P., Willberg, B., Hirzinger, G., 2006. The development of a new biomechatronic prosthetic hand based on under-actuated mechanism. In: *Proceedings, IEEE/RSJ International Conference on Intelligent Robots and Systems*.
- Jeannerod, M., Arbib, M.A., Rizzolatti, G., Sakata, H., 1995. Grasping objects: the cortical mechanisms of visuomotor transformation. *Trends Neuroscience* 18, 314–320.
- Kapandji, A., 1998. *The Physiology of the Joints*. Churchill Livingstone, Edinburgh.
- Kapandji, A., 2006. *Personal Communication*.
- Kawasaki, H., Komatsu, T., Uchiyama, K., 2002. Dexterous anthropomorphic robot hand with distributed tactile sensor: Gifu hand II. *IEEE/ASME Transactions on Mechatronics* 7 (3), 296–303.
- Klein, C.S., Rice, C.L., Marsh, G.D., 2001. Normalized force, activation, and coactivation in the arm muscles of young and old men. *Journal of Applied Physiology* 91, 1341–1349.
- Klute, G.K., 1999. *Artificial Muscles: Actuators for Biorobotic Systems*. Ph.D. Dissertation, University of Washington.
- Klute, G.K., Czerniecki, J.M., Hannaford, B., 1999. McKibben artificial muscles: pneumatic actuators with biological intelligence. In: *IEEE/ASME 1999 International Conference on Advanced Intelligent Mechatronics*, September 19–22, Atlanta.
- Koganezawa, K., Ban, S., 2002. Stiffness control of antagonistically driven redundant D.O.F. manipulator. In: *Proceedings of the IEEE International Conference on Intelligent Robots and Systems, Lausanne*, pp. 2280–2285.
- Koganezawa, K., 2005. Mechanical stiffness control for antagonistically driven joints. In: *Proceedings of the IEEE International Conference on Intelligent Robots and Systems, Edmonton, Alberta*, pp. 1544–1551.
- Kuczynski, K., 1975. The thumb and the saddle. *Hand* 7, 120–122.
- Lacquaniti, F., Terzuolo, C., Viviani, P., 1983. The law relating kinematic and figural aspects of drawing movements. *Acta Psychologica* 54, 115–130.
- Lovchik, C., Diftler, M., 1999. A dexterous hand for space. In: *Proceedings of the IEEE International Conference on Robotics and Automation*, pp. 907–912.
- Maier, S., van der Smagt, P., 2008. Surface EMG suffices to classify the motion of each finger independently. In: *Proceedings of MOVIC 2008, 9th International Conference on Motion and Vibration Control, Technische Universität München*.
- Marr, D.A., 1969. A theory of cerebellar cortex. *Journal of Physiology* 202, 437–470.
- Migliore, S.A., Brown, E.A., Deweerth, S.P., 2005. Biologically inspired joint stiffness control. In: *Proceedings of the IEEE International Conference on Robotics and Automation, Barcelona*, pp. 4519–4524.
- Morita, T., Sugano, S., 1995. Design and development of a new robot joint using a mechanical impedance adjuster. In: *Proceedings of the IEEE International Conference on Robotics and Automation, Barcelona*, pp. 2469–2475.
- Novak, K.E., Miller, L.E., Houk, J.C., 2002. The use of overlapping submovements in the control of rapid hand movements. *Experimental Brain Research* 144, 351–364.

- Osu, R., Gomi, H., 1999. Multijoint muscle regulation mechanisms examined by measured human arm stiffness and EMG signals. *Journal of Neurophysiology* 81 (4), 1458–1468.
- OttoBock, 2008. Otto Bock SensorHand Hand Prosthesis. <<http://www.ottobockus.com/products/upperlimbprosthetics/myoelectrichandssensorhand.asp2>>.
- Riley, M., Atkeson, C., 2002. Robot catching: towards engaging human–humanoid interaction. *Autonomous Robots* 12, 119–128.
- Rizzolatti, G., Gentilucci, M., Camarda, R.M., Gallese, V., Luppino, G., Matelli, M., Fogassi, L., 1990. Neurons related to reaching-grasping arm movements in the rostral part of area 6 (area 6a $\beta$ ). *Experimental Brain Research* 82, 337–350.
- Schoelkopf, B., Smola, A.J., 2002. *Learning with Kernels*. MIT Press, Cambridge, MA.
- Shahinpoor, M., Kim, K.J., Mojjarrad, M., 2007. Artificial Muscles: Applications of Advances Polymeric Nanocomposites. CRC Press, Boca Raton, FL. pp. 23–39, 115, 153, 189.
- Sinapius, M., 2007. Lecture, Adaptronik, vol. 1. Otto-von-Guericke Universität Magdeburg.
- Toki, Co., 2009. 3–43-15 Omorikita Ota-ku, 143-0016, Tokyo, Japan. BioMetal fiber, BMF Series. <[http://www.toki.co.jp/BioMetal/Download/DownloadFiles/BMF\\_eng.pdf](http://www.toki.co.jp/BioMetal/Download/DownloadFiles/BMF_eng.pdf)>.
- Tonietti, G., Schiavi, R., Bicchi, A., 2005. Design and control of a variable stiffness actuator for safe and fast physical human/robot interaction. In: *Proceedings of the IEEE International Conference on Robotics and Automation*, Barcelona, pp. 528–533.
- TouchBionics, 2007. The i-Limb System, 2007. <<http://www.touchbionics.com2>>.
- Vanderborght, B., 2007. Dynamic Stabilisation of the Biped Lucy Powered by Actuators with Controllable Stiffness. Ph.D. Dissertation, Vrije Universiteit Brussel.
- Verrelst, B., Daerden, F., Lefeber, D., Van Ham, R., Fabri, T., 2000. Introducing pleated pneumatic artificial muscles for the actuation of legged robots: a one-dimensional set-up. In: *Proceedings of the CLAWAR 2000: 3rd International Conference*, Madrid, pp. 583–590.
- Vijayakumar, S., D'Souza, A., Schaal, S., 2005. Incremental Online Learning in High Dimensions. Tech Report EDI-INF-RR-0284 of UEDIN.