

# Communication (III)

**Kai Huang**

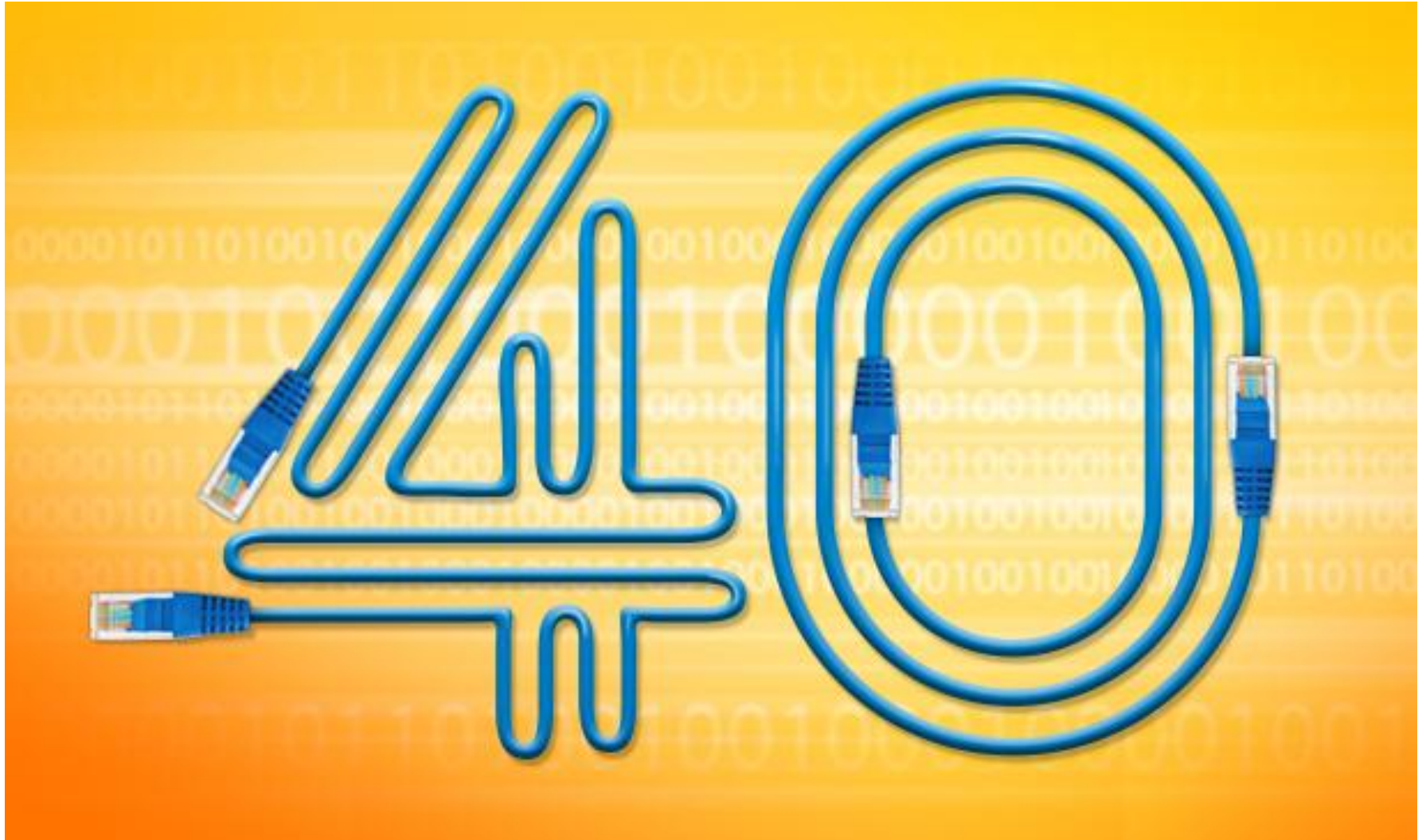

# Ethernet Turns 40



# Outline

- Bus basics
- Multiple Master Bus
- Network-on-Chip
- **Examples**
  - SPI
  - CAN
  - FlexRay
  - **Ethernet**
    - Basic
    - OSI model
    - Real-Time Ethernet
    - Future of Ethernet



# Cables

Shielded twisted pair (STP)



Unshielded twisted pair (UTP)

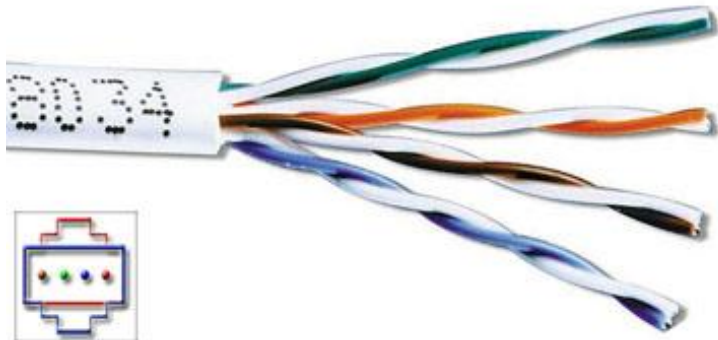

COAXIAL CABLE

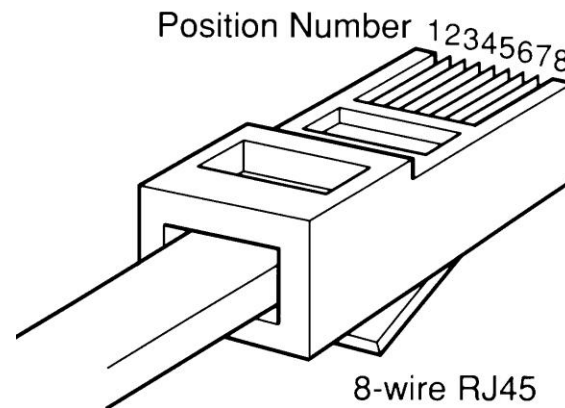

# Ethernet

## History

- Developed by Bob Metcalfe and others at Xerox PARC in mid-1970s
- Roots in Aloha packet-radio network
- Standardized by Xerox, DEC, and Intel in 1978
- LAN standards define MAC and physical layer connectivity
  - IEEE 802.3 (CSMA/CD - Ethernet) standard – originally 2Mbps
  - IEEE 802.3u standard for 100Mbps Ethernet
  - IEEE 802.3z standard for 1,000Mbps Ethernet

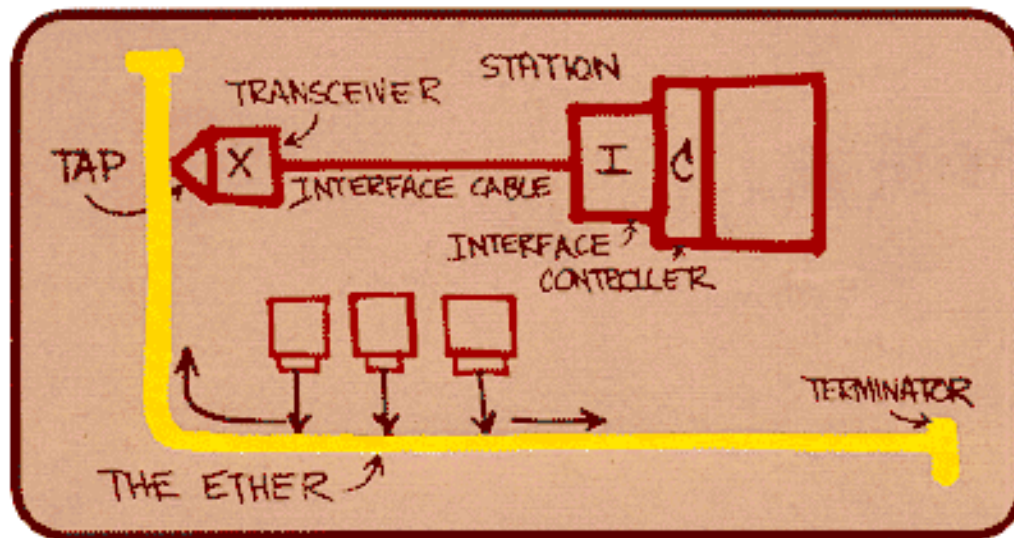

Metcalfe's original Ethernet Sketch

# Overview

- Most popular packet-switched LAN technology
- Bandwidths: 10Mbps, 100Mbps, 1Gbps
- Max bus length: 2500m
  - 500m segments with 4 repeaters
- Bus and Star topologies are used to connect hosts
  - Hosts attach to network via Ethernet transceiver or hub or switch
    - Detects line state and sends/receives signals
  - Hubs are used to facilitate shared connections
  - All hosts on an Ethernet are competing for access to the medium
    - Switches break this model



# State Diagram for CSMA/CD

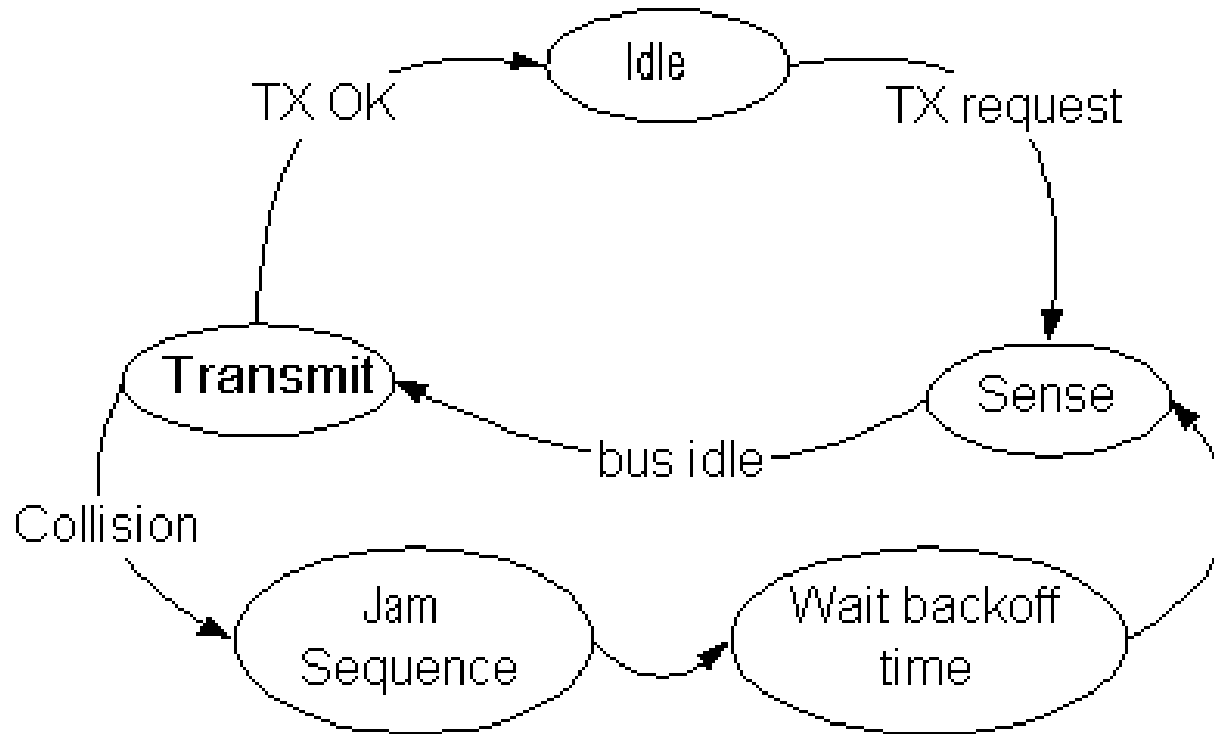

# CSMA/CD Principle

- In CSMA/CD a station **must never** be allowed to believe it has transmitted a frame successfully if that frame has, in fact, experienced a collision.
- In the worst case it takes **twice** the maximum propagation delay across the network before a station can be sure that a transmission has been successful. If a station sends a really short frame, it may actually finish sending and release the Ether without realising that a collision has occurred.





# Collision Detection

- 1) At time  $t=0$ , a frame is sent on the idle medium by NIC A
- 2) A short time later, NIC B also transmits
- 3) After a period, equal to the propagation delay of the network, the NIC at B detects the other transmission from A (e.g., excess current above what it is generating), B sends Jam sequence
- 4) After one complete round trip propagation time (twice the one way propagation delay), both NICs are aware of the collision

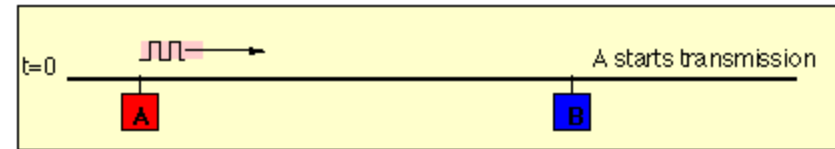

1)

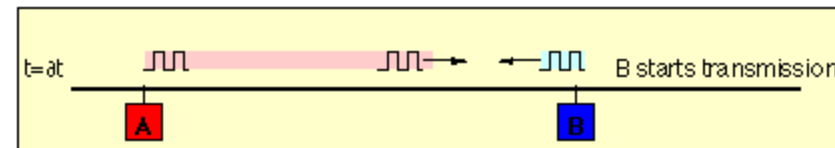

2)

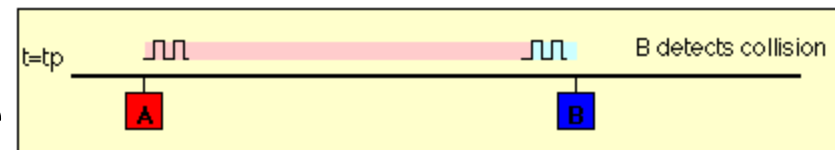

3)

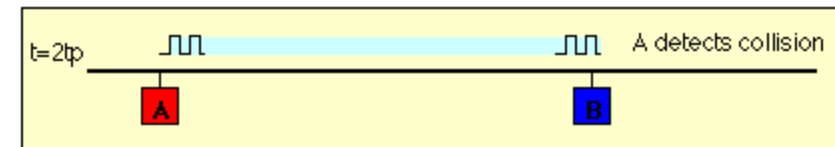

4)

# Collision Detection

- How can A know that a collision has taken place?
  - There must be a mechanism to insure retransmission on collision
  - A's message reaches B at time  $T$
  - B's message reaches A at time  $2T$
  - So, A must still be transmitting at  $2T$
- IEEE 802.3 specifies max value of  $2T$  to be  $51.2\mu\text{s}$ 
  - At  $10\text{Mbps}$  it takes  $0.1\mu\text{s}$  to transmit one bit so  $512$  bits ( $64\text{B}$ ) take  $51.2\mu\text{s}$  to send
  - So, Ethernet frames must be at least  $64\text{B}$  long
    - $14\text{B}$  header,  $46\text{B}$  data,  $4\text{B}$  CRC
    - Padding is used if data is less than  $46\text{B}$
- Send jamming signal after collision is detected to insure all hosts see collision
  - $48$  bit signal



# Exponential Backoff

- If a collision is detected, delay and try again
- Delay time is selected using binary exponential backoff
  - 1st time: choose  $K$  from  $\{0,1\}$  then delay =  $K * 51.2\mu s$
  - 2nd time: choose  $K$  from  $\{0,1,2,3\}$  then delay =  $K * 51.2\mu s$
  - $n$ th time: delay =  $K * 51.2\mu s$ , for  $K=0..2^n - 1$ 
    - Note max value for  $k = 1023$
  - give up after several tries (usually 16)
    - Report transmit error to host
- If delay were not random, then there is a chance that sources would retransmit in lock step
- Why not just choose from small set for  $K$ 
  - This works fine for a small number of hosts
  - Large number of nodes would result in more collisions



# Fast and Gigabit Ethernet

- Fast Ethernet (100Mbps) has technology very similar to 10Mbps Ethernet
  - Uses different physical layer encoding (4B5B)
  - Many NIC's are 10/100 capable
    - Can be used at either speed
- Gigabit Ethernet (1,000Mbps)
  - Compatible with lower speeds
  - Uses standard framing and CSMA/CD algorithm
  - Distances are severely limited
  - Typically used for backbones and inter-router connectivity
  - Becoming cost competitive
  - How much of this bandwidth is realizable?



# Experiences with Ethernet

- Ethernets work best under light loads
  - Utilization over 30% is considered heavy (Peak utilization approx. =  $1/e$  = 37%)
    - Network capacity is wasted by collisions
- Most networks are limited to about 200 hosts
  - Specification allows for up to 1024
- Most networks are much shorter
  - 5 to 10 microsecond RTT
- Transport level flow control helps reduce load (number of back to back packets)
- Ethernet is inexpensive, fast and easy to administer!



# Ethernet Problems

- Ethernet's peak utilization is pretty low (like Aloha)
- Peak throughput worst with
  - More hosts
    - More collisions needed to identify single sender
  - Smaller packet sizes
    - More frequent arbitration
  - Longer links
    - Collisions take longer to observe, more wasted bandwidth
  - Efficiency is improved by avoiding these conditions
- Why did Ethernet Win?
  - **Price !**



# Outline

- Bus basics
- Multiple Master Bus
- Network-on-Chip
- **Examples**
  - SPI
  - CAN
  - FlexRay
  - **Ethernet**
    - Basic
    - OSI model
    - Real-Time Ethernet
    - Future of Ethernet



# Open Systems Interconnection (OSI) Model

- OSI is a 7-layer abstraction model for standardizing the functions of communication systems
- Standardized by the International Organization for Standardization (ISO): ISO/IEC 7498-1
- OSI Layers exchange Service Data Units (SDUs)
- Peers exchange Protocol Data Units (PDUs)

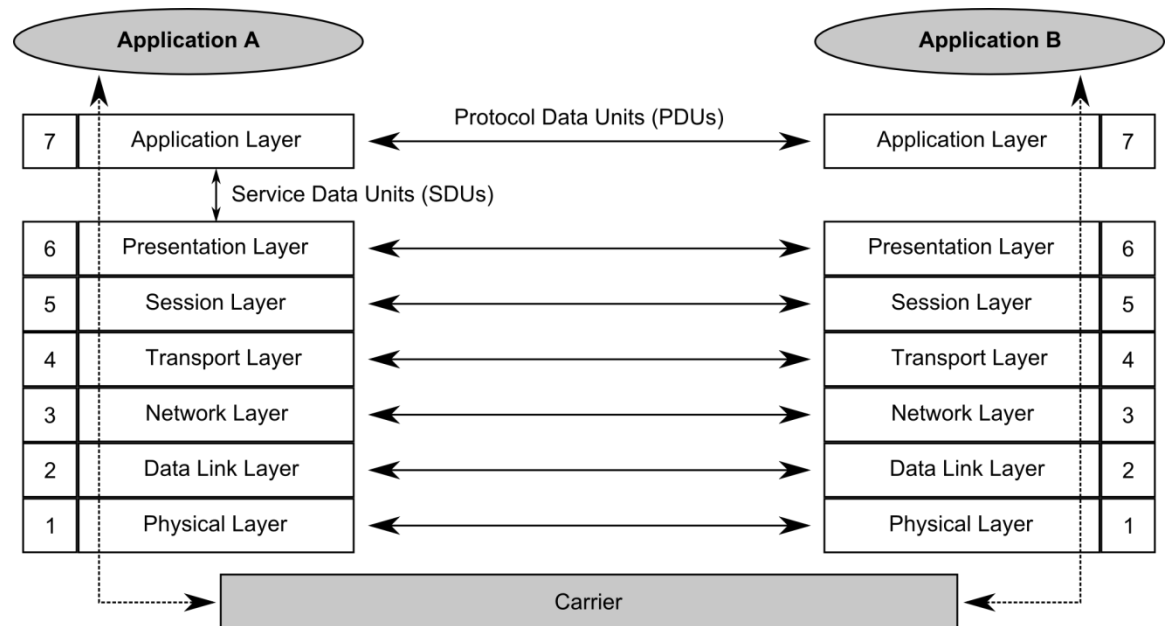



# Open Systems Interconnection (OSI) Model

- OSI is a 7-layer abstraction model for standardizing the functions of communication systems
- Standardized by the International Organization for Standardization (ISO): ISO/IEC 7498-1
- OSI Layers exchange Service Data Units (SDUs)
- Peers exchange Protocol Data Units (PDUs)
- In real-time systems typically only **three** layers are implemented

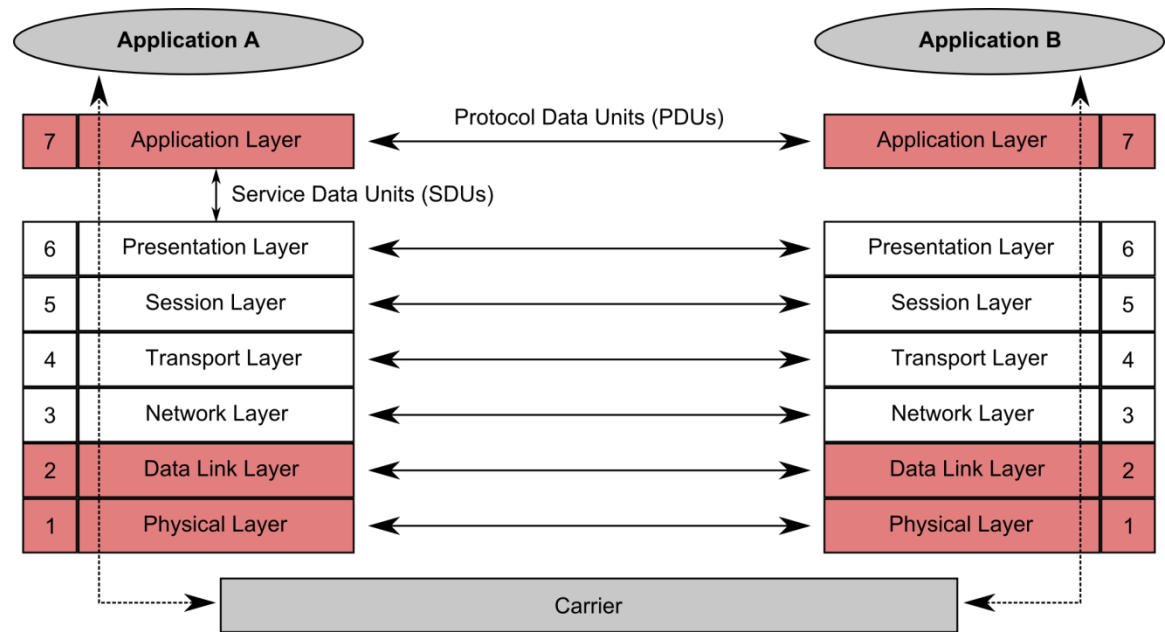

Ethernet → MAC and physical layer of Internet

# OSI Model: Physical Layer

- Conveys the bit stream (e.g., electrical impulse, light or radio signal)
- Defines electrical, mechanical, functional and procedural properties of physical connection (e.g. plugs and cables)
- Defines encoding
- Important encodings:
  - NRZ (Non-Return-To-Zero)
  - Manchester

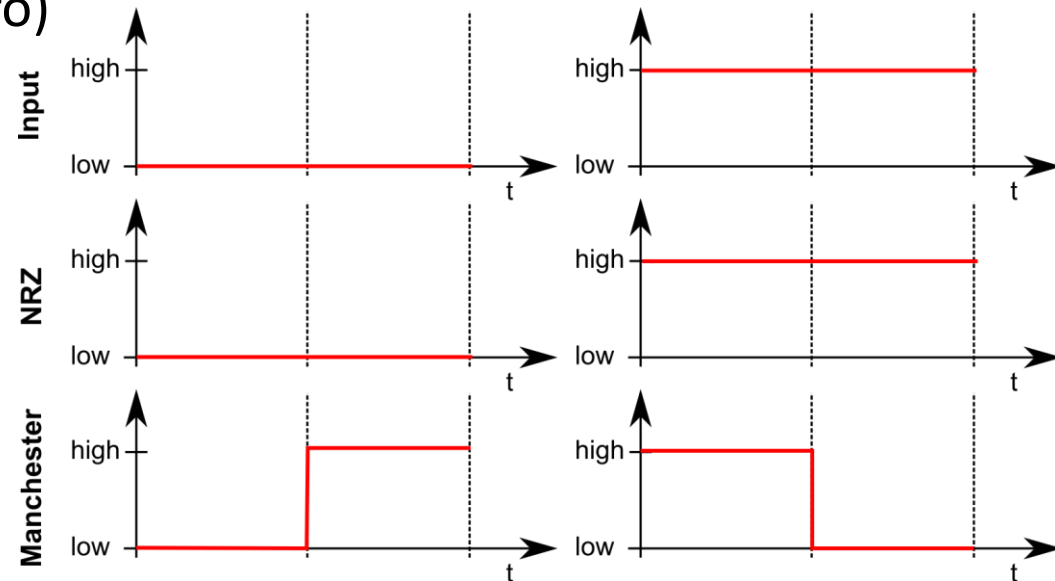

# OSI Model: Physical Layer

- Problem of NRZ Code  
Long series of 0s or 1s do not induce a level change. Therefore, sender and receiver have to be in sync (either via internal clocks or via an additional clock line).
- Problem can be avoided by using ***bit-stuffing***.

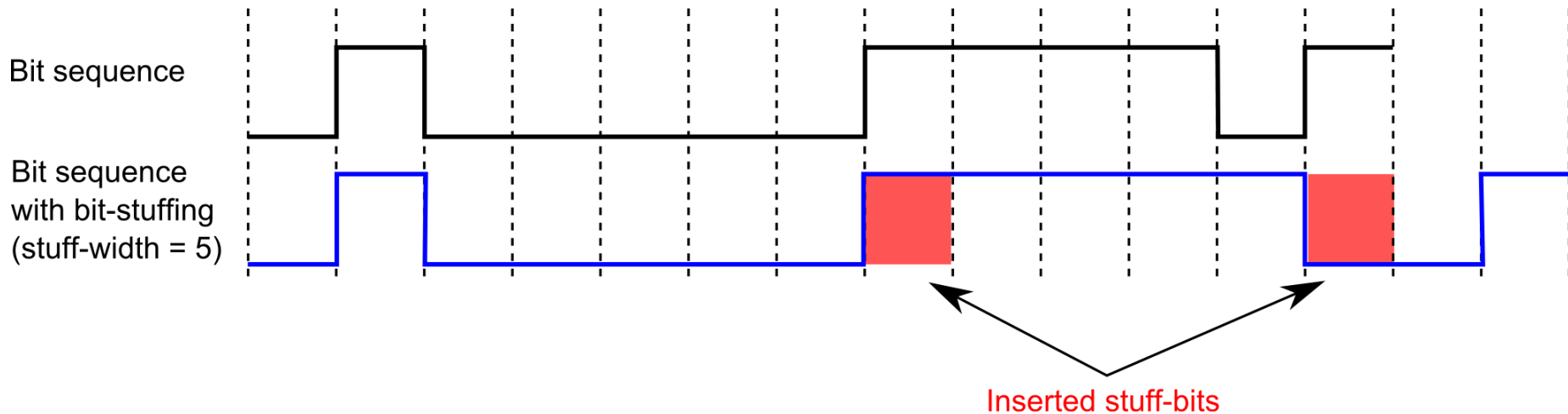

# OSI Model: Data Link Layer

- In some protocols (e.g. IEEE 802) separated in two sub-layers:
  - 2a: Media Access Control (MAC)
  - 2b: Logical Link Control (LLC)
- Flow control
- Media access control
- Error detection (checksums, parity bits)

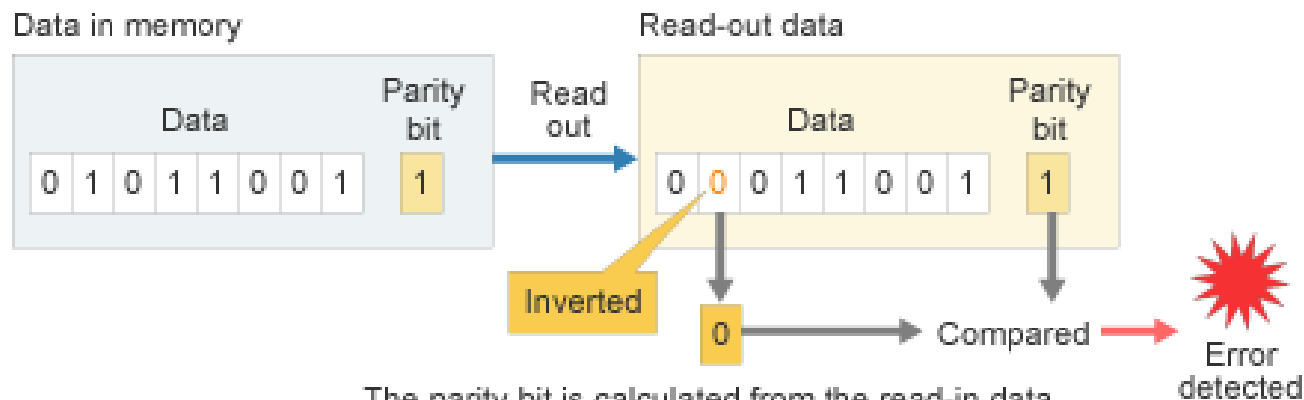

The parity bit is calculated from the read-in data.  
Since the number of 1s is an odd number, the parity bit is "0".

# OSI Model: Application Layer

- Provides application-specific communication services
- Examples:
  - File Transfer (e.g. FTP)
  - E-Mail
  - Virtual Terminal
  - Remote Login
  - Voice-over-IP (VoIP)
  - Video-On-Demand



# Outline

- Bus basics
- Multiple Master Bus
- Network-on-Chip
- **Examples**
  - SPI
  - CAN
  - FlexRay
  - **Ethernet**
    - Basic
    - OSI model
    - **Real-Time Ethernet**
    - Future of Ethernet



# What is Real-Time Ethernet

- Synonyms: Time-Triggered Ethernet
- Goal: To use standard Ethernet hardware and infrastructure for real-time applications (e.g., automation, automotive, avionic, ...)
- Producers
  - EtherCAT (Beckhoff)
  - Profinet (Siemens)
  - TT-Ethernet (TTTech)



# Why RT-Ethernet ?

- Existing time-triggered solutions work with bandwidths
  - TTP/C . 25 Mbit/s,
  - FlexRay -10 Mbit/sec
  - TTCAN . 1 Mbit/sec
  - All these are lower than those of most used network technology, i.e., Ethernet
  - ASIC implementation of comm. controllers (TTP/C, FlexRay, TTCAN)
- Cheap hardware
- Ethernet is everywhere, most dominant network
- **Problem**
  - **Standard Ethernet (IEEE 802.3) does not support realtime applications**





# IEEE 802.3 Recall

- IEEE 802.3 uses CSMA/CD
- Collision:
  - Nodes stop transmission
  - Nodes send Jam signal
  - Nodes wait backoff time then try to retransmit

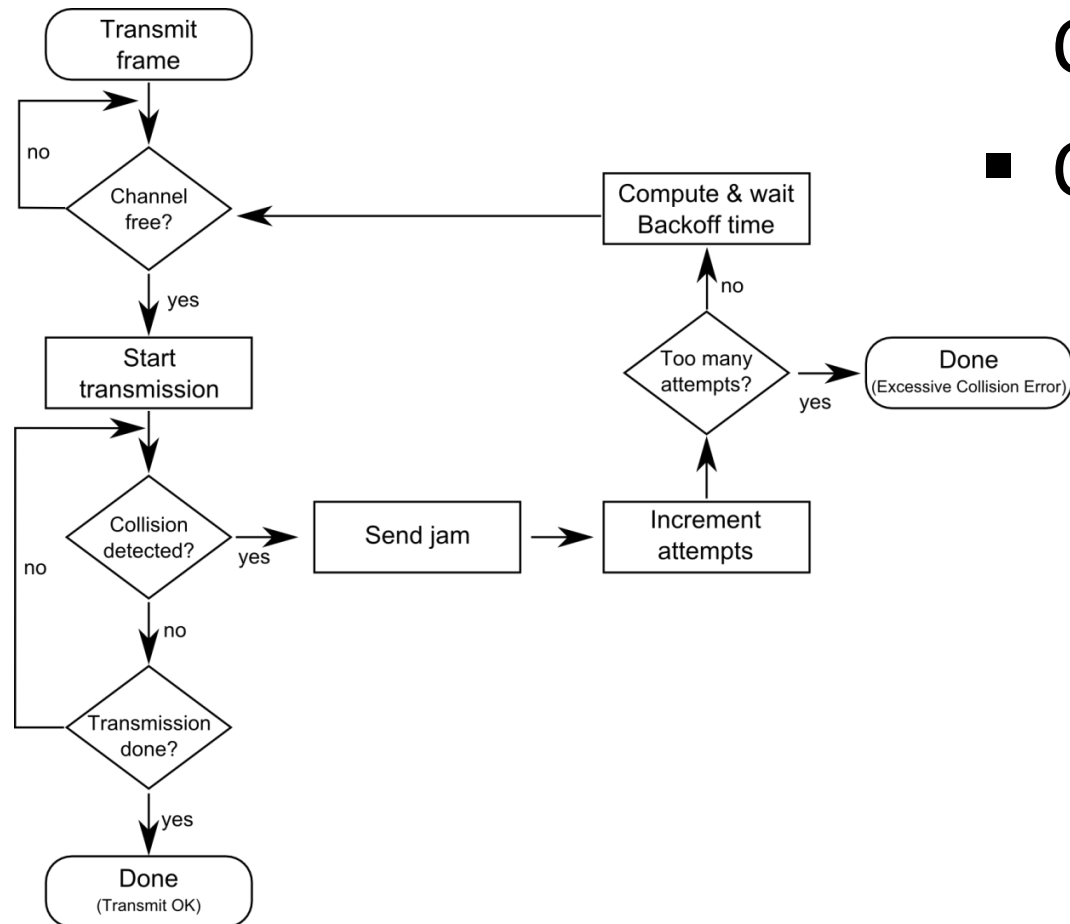

# Time-Triggered Ethernet (from TU WIEN )

- Supports **two** message types: standard (ET) Ethernet messages and TT Ethernet messages.
- Message Format and Addressing adhere to the Ethernet Standard.
- Standard Ethernet controller in end systems
- TT messages are transported with small **constant** delay.
- Schedule for TT messages contained in the TTE switch to protect the network from babbling idiots.
- Clock Sync on top of TT Ethernet



# Time-Triggered Ethernet - Configuration

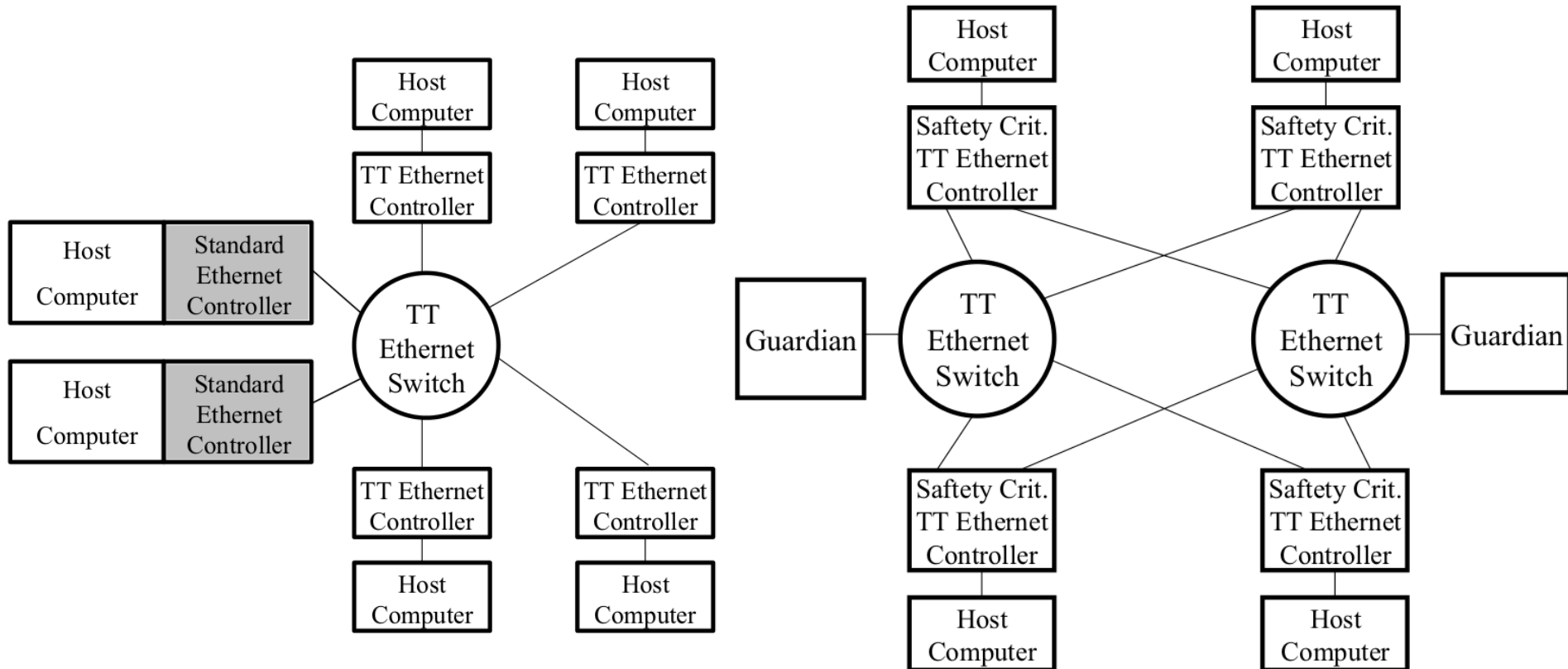

# Principle of Operation

- TT Ethernet switch - transmits TT msg. with a constant delay.
- Transmission of ET msg. is preempted,
  - if during the transmission a TT msg. arrives at a switch port, ET msg. is stored in the buffer of the switch, and retransmitted as soon as the transmission of the TT msg. is finished
- If during the transmission of TT msg. an ET msg. arrives in a port of the switch, the ET msg. is stored in the buffer of the switch and transmitted after the transmission of TT msg. is finished



# TT Ethernet - Time Format

## Time horizon

about 30 000 years,  
elapsed seconds since  
January 6, 1980 at 00:00(GPS base).

## Time granularity

about 60 nanoseconds  
determined by  
the precision of GPS

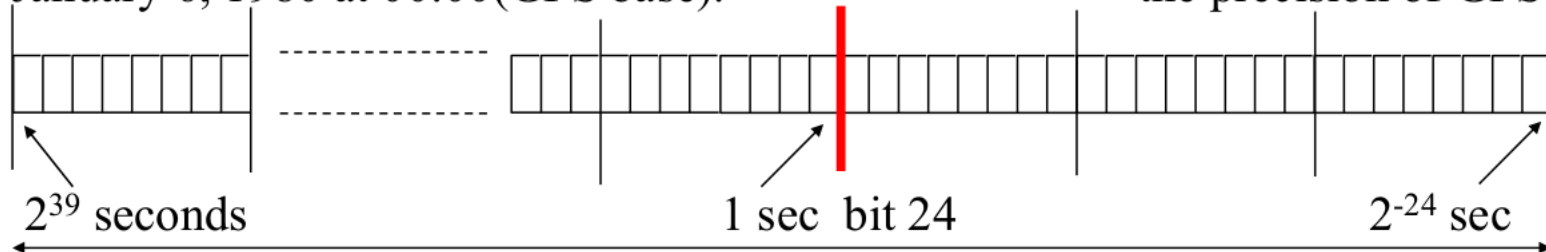

TT Ethernet time format (8 bytes)

# TT Ethernet - Time Format (2)

Period ID (Msg ID)

Period bit				Phase bit											
0	1	2	3	4	5	6	7	8	9	10	11	12	13	14	15

Period of  $1/2^4$  (i.e., 1/16)

Phase of  $1/2^6 + 1/2^{11} = 16113$  sec

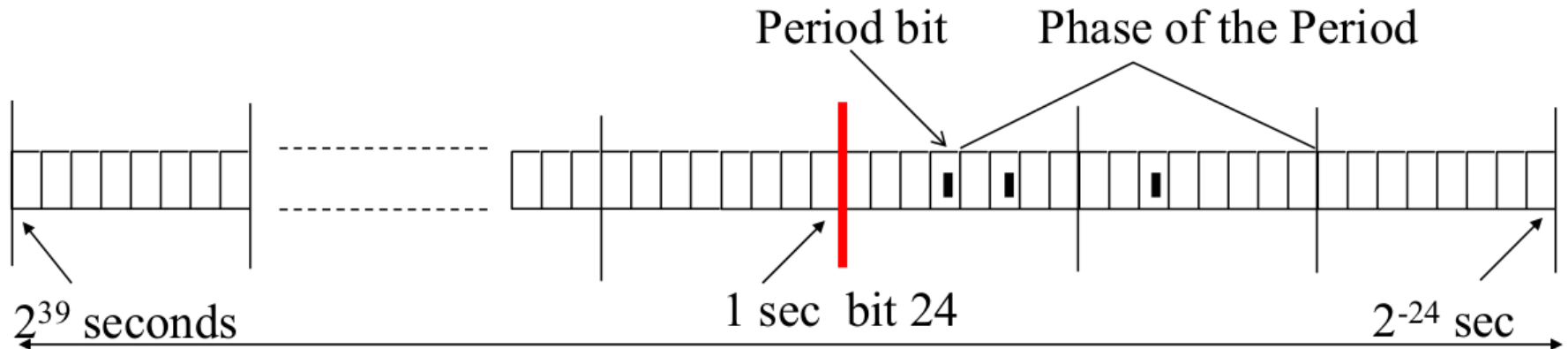

# TTE Frames

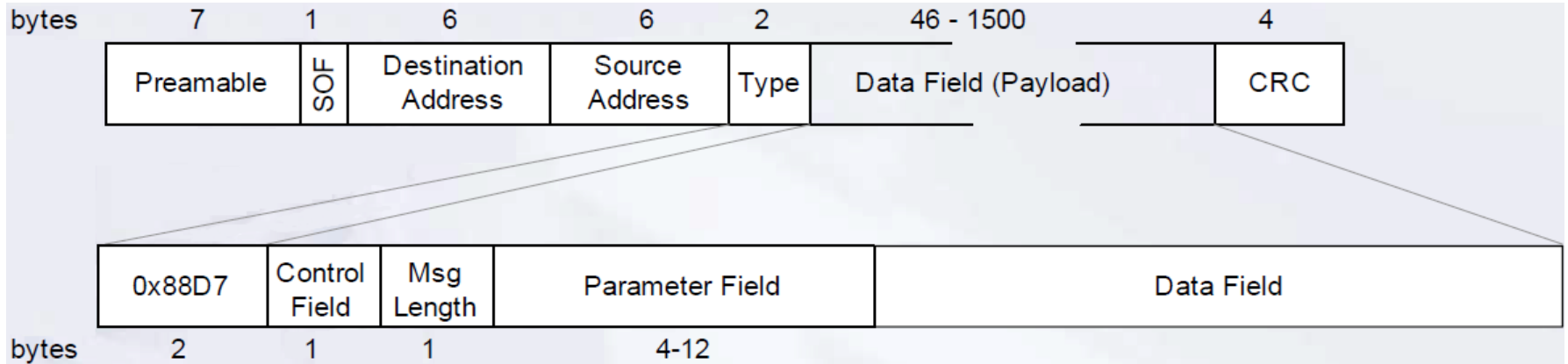

- Standard Ethernet frames
- Standard frame type field 0x88D7
- Ethernet data field contains the header and the data fields of different TT Ethernet frames

# Communication Schedule Example

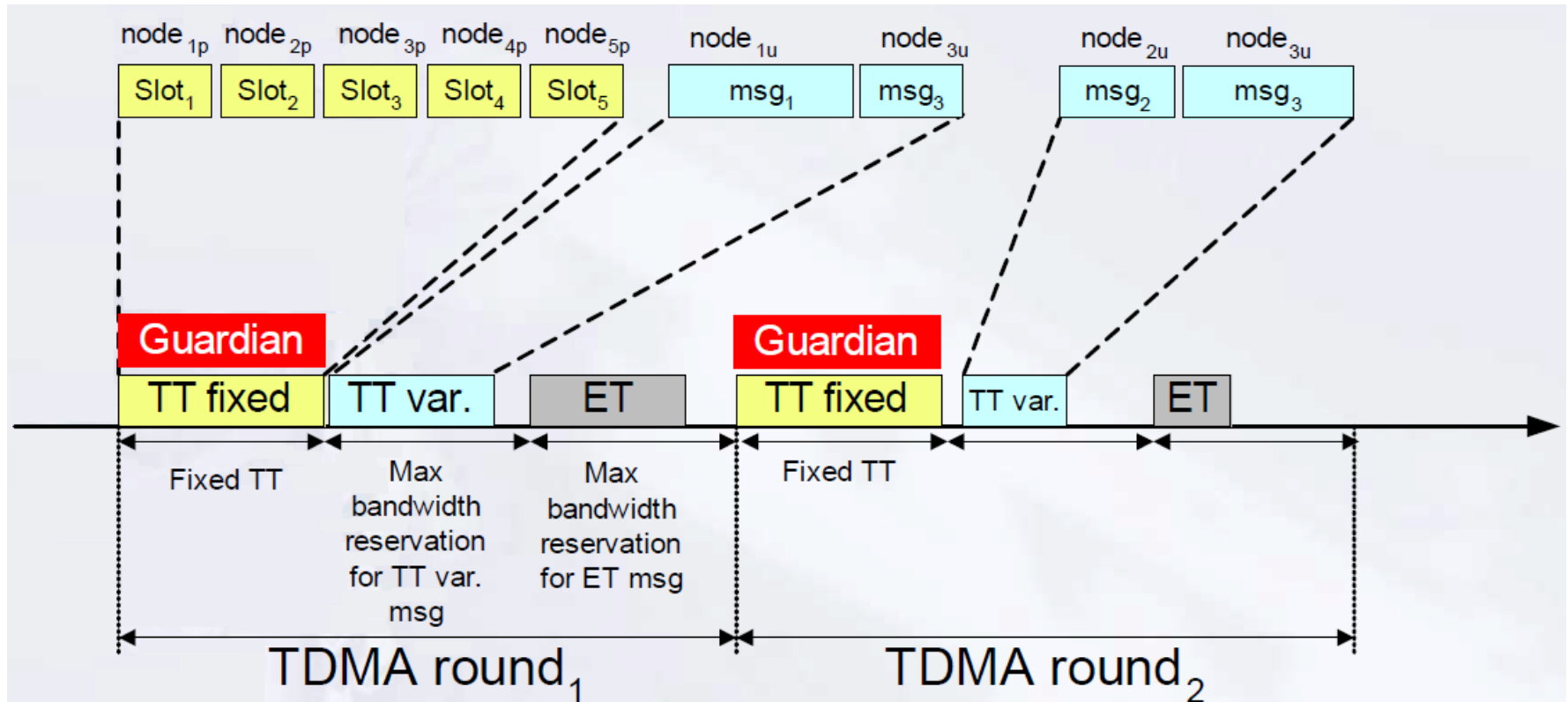



# A last word from Bob

Q: Is there anything you'd do different with Ethernet, now knowing what you know?

A: I would not have described Ethernet's multi-access packet contention as "collisions." Buyers too often thought wrongly that Ethernet collisions were like breaking glass and bent metal. There are still people today who are forced to use Ethernet but complain about it being "non-deterministic" because of those damn collisions. **There has not been a reported Ethernet collision in decades.**

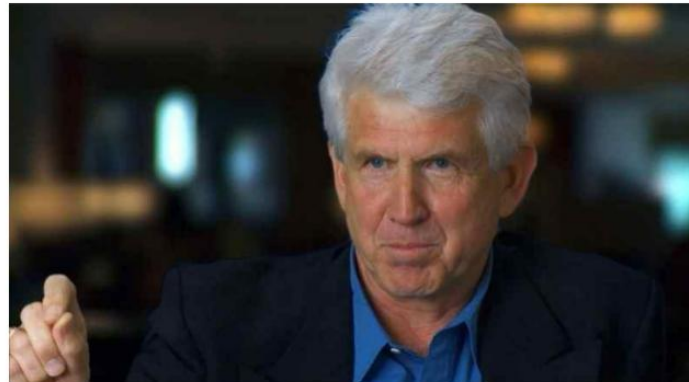

September 2013

The 3rd Ethernet & IP @  
Automotive Technology Day

47



12/17/2013

Kai.Huang@tum

33



# Outline

- Bus basics
- Multiple Master Bus
- Network-on-Chip
- **Examples**
  - SPI
  - CAN
  - FlexRay
  - **Ethernet**
    - Basic
    - OSI model
    - Real-Time Ethernet
    - **Future of Ethernet**



# Ethernet Backbone in Car: Hype or Reality?

- Broadcom: “Carmakers have come to a collective conclusion” to embrace automotive Ethernet”
  - carmakers today are "paying more attention to what electronics devices their customers are bringing into the car -- moreso than a car's horsepower.”
  - There are many "islands of networks" inside a car today, which don't interoperate
  - Carmakers need scalable solutions for in-car networking
- Start seeing automotive Ethernet replacing CAN in eight to 10 years



# Some Claims

- 100 Ethernet nodes for a high-end car in 2020
  - Five domain controllers on the backbone (powertrain, safety, chassis, body, infotainment), 10 to 20 infotainment nodes, 10 to 15 nodes for advanced safety, 1 node for diagnostics, and 10 to 20 additional nodes for other high-end features.
- Single-pair Automotive Ethernet, which uses unshielded twisted pair (UTP) cable to deliver data at a rate of 100Mbps, along with smaller and more compact connectors “can reduce connectivity cost up to 80 percent and cabling weight up to 30 percent,” according to Broadcom.



# Our Ethernet-Car Prototype

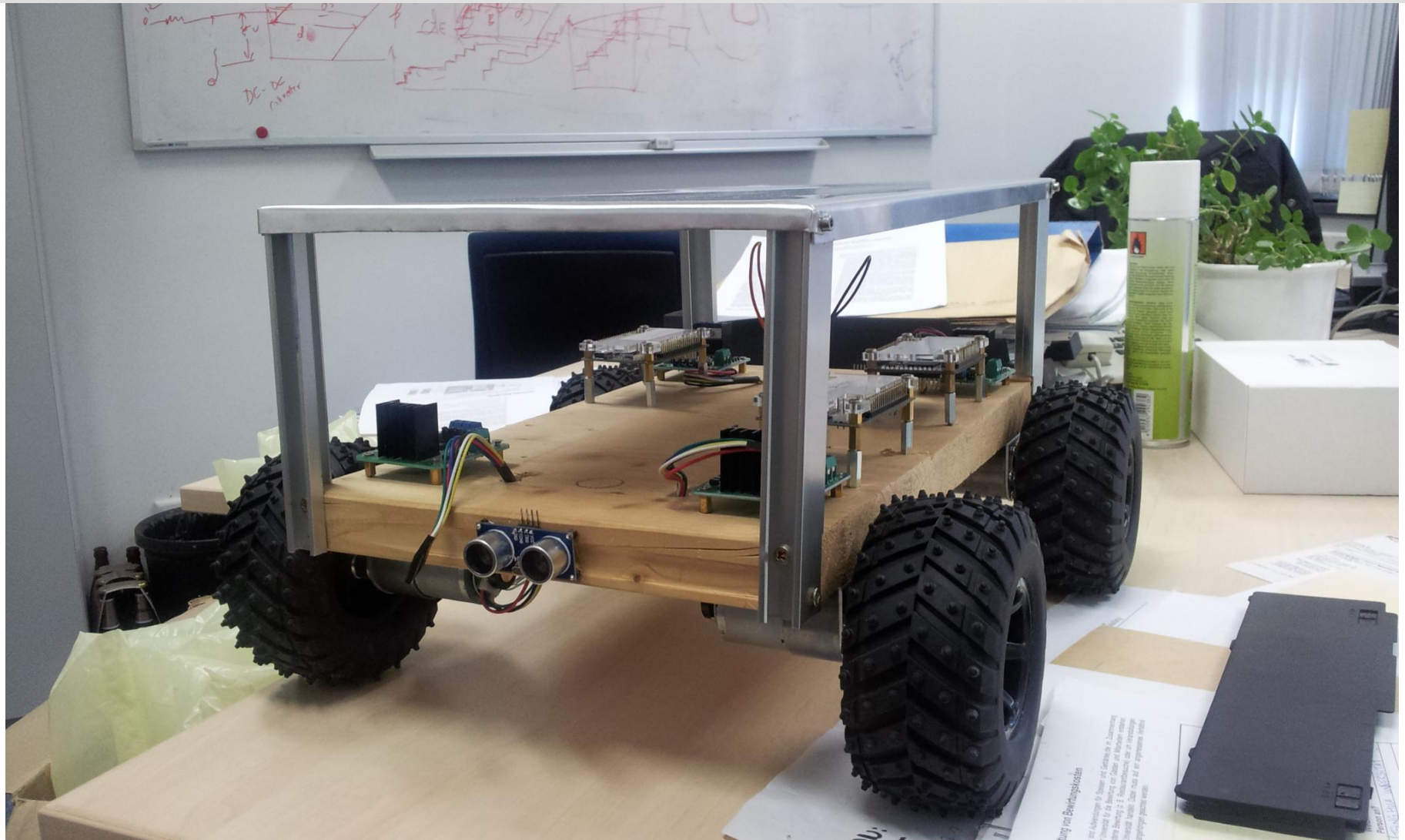

12/17/2013

Kai.Huang@tum

37

